

STAMFORD[®]

HCI636K - Winding 312

Technical  Data Sheet

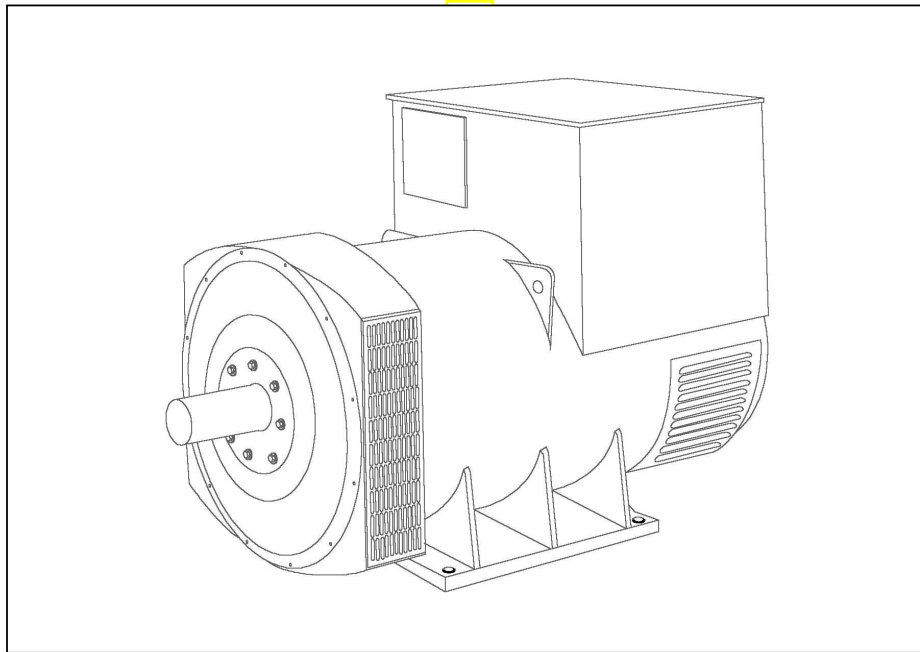

HCI636K

SPECIFICATIONS & OPTIONS

STAMFORD

STANDARDS

Stamford industrial generators meet the requirements of BS EN 60034 and the relevant section of other international standards such as BS5000, VDE 0530, NEMA MG1-32, IEC34, CSA C22.2-100, AS1359.

Other standards and certifications can be considered on request.

VOLTAGE REGULATORS

MX321 AVR - STANDARD

This sophisticated Automatic Voltage Regulator (AVR) is incorporated into the Stamford Permanent Magnet Generator (PMG) system and is fitted as standard to generators of this type.

The PMG provides power via the AVR to the main exciter, giving a source of constant excitation power independent of generator output. The main exciter output is then fed to the main rotor, through a full wave bridge, protected by a surge suppressor. The AVR has in-built protection against sustained over-excitation, caused by internal or external faults. This de-excites the machine after a minimum of 5 seconds.

Over voltage protection is built-in and short circuit current level adjustments is an optional facility.

WINDINGS & ELECTRICAL PERFORMANCE

All generator stators are wound to 2/3 pitch. This eliminates triplen (3rd, 9th, 15th ...) harmonics on the voltage waveform and is found to be the optimum design for trouble-free supply of non-linear loads. The 2/3 pitch design avoids excessive neutral currents sometimes seen with higher winding pitches, when in parallel with the mains. A fully connected damper winding reduces oscillations during paralleling. This winding, with the 2/3 pitch and carefully selected pole and tooth designs, ensures very low waveform distortion.

TERMINALS & TERMINAL BOX

Standard generators feature a main stator with 6 ends brought out to the terminals, which are mounted on the frame at the non-drive end of the generator. A sheet steel terminal box contains the AVR and provides ample space for the customers' wiring and gland arrangements. It has removable panels for easy access.

SHAFT & KEYS

All generator rotors are dynamically balanced to better than BS6861:Part 1 Grade 2.5 for minimum vibration in operation. Two bearing generators are balanced with a half key.

INSULATION/IMPREGNATION

The insulation system is class 'H'.

All wound components are impregnated with materials and processes designed specifically to provide the high build required for static windings and the high mechanical strength required for rotating components.

QUALITY ASSURANCE

Generators are manufactured using production procedures having a quality assurance level to BS EN ISO 9001.

The stated voltage regulation may not be maintained in the presence of certain radio transmitted signals. Any change in performance will fall within the limits of Criteria 'B' of EN 61000-6-2:2001. At no time will the steady-state voltage regulation exceed 2%.

DE RATES

All values tabulated on page 8 are subject to the following reductions

5% when air inlet filters are fitted.

10% when IP44 Filters are fitted.

3% for every 500 metres by which the operating altitude exceeds 1000 metres above mean sea level.

3% for every 5°C by which the operational ambient temperature exceeds 40°C.

Note: Requirement for operating in an ambient exceeding 60°C must be referred to the factory.

NB Continuous development of our products entitles us to change specification details without notice, therefore they must not be regarded as binding.

Front cover drawing typical of product range.

APPROVED DOCUMENT

WINDING 312

CONTROL SYSTEM	SEPARATELY EXCITED BY P.M.G.	
A.V.R.	MX321	
VOLTAGE REGULATION	± 0.5 %	With 4% ENGINE GOVERNING
SUSTAINED SHORT CIRCUIT	REFER TO SHORT CIRCUIT DECREMENT CURVES (page 7)	

INSULATION SYSTEM	CLASS H
PROTECTION	IP23
RATED POWER FACTOR	0.8
STATOR WINDING	DOUBLE LAYER LAP
WINDING PITCH	TWO THIRDS
WINDING LEADS	6
STATOR WDG. RESISTANCE	0.0039Ohms PER PHASE AT 22°C STAR CONNECTED
ROTOR WDG. RESISTANCE	1.75 Ohms at 22°C
EXCITER STATOR RESISTANCE	17 Ohms at 22°C
EXCITER ROTOR RESISTANCE	0.1 Ohms PER PHASE AT 22°C
R.F.I. SUPPRESSION	BS EN 61000-6-2 & BS EN 61000-6-4,VDE 0875G, VDE 0875N. refer to factory for others
WAVEFORM DISTORTION	NO LOAD < 1.5% NON-DISTORTING BALANCED LINEAR LOAD < 5.0%
MAXIMUM OVERSPEED	1500 Rev/Min
BEARING DRIVE END	BALL. 6224 (ISO)
BEARING NON-DRIVE END	BALL. 6317 (ISO)

	1 BEARING	2 BEARING
WEIGHT COMP. GENERATOR	2307 kg	2276 kg
WEIGHT WOUND STATOR	1078 kg	1008 kg
WEIGHT WOUND ROTOR	1025 kg	1005 kg
WR ² INERTIA	27.7814 kgm ²	27.2379 kgm ²
SHIPPING WEIGHTS in a crate	2367kg	2336kg
PACKING CRATE SIZE	194 x 92 x 147(cm)	194 x 92 x 147(cm)

	50 Hz	60 Hz
TELEPHONE INTERFERENCE	THF<2%	TIF<50

COOLING AIR	1.614 m ³ /sec 3420 cfm	1.961 m ³ /sec 4156 cfm
-------------	------------------------------------	------------------------------------

VOLTAGE STAR	380/220	400/231	415/240	440/254	416/240	440/254	460/266	480/277
VOLTAGE DELTA	220	230	240	254	240	254	266	277
kVA BASE RATING FOR REACTANCE VALUES	570	570	570	570	675	713	713	713
X _d DIR. AXIS SYNCHRONOUS	1.93	1.74	1.62	1.44	2.28	2.15	1.97	1.81
X' _d DIR. AXIS TRANSIENT	0.19	0.17	0.16	0.14	0.23	0.21	0.20	0.18
X'' _d DIR. AXIS SUBTRANSIENT	0.16	0.14	0.13	0.12	0.19	0.18	0.16	0.15
X _q QUAD. AXIS REACTANCE	1.21	1.09	1.01	0.90	1.42	1.34	1.23	1.13
X'' _q QUAD. AXIS SUBTRANSIENT	0.17	0.15	0.14	0.12	0.20	0.19	0.17	0.16
X _L LEAKAGE REACTANCE	0.07	0.07	0.06	0.05	0.09	0.08	0.07	0.07
X ₂ NEGATIVE SEQUENCE	0.17	0.15	0.14	0.12	0.20	0.19	0.17	0.16
X ₀ ZERO SEQUENCE	0.11	0.10	0.09	0.08	0.13	0.12	0.11	0.10

REACTANCES ARE SATURATED

VALUES ARE PER UNIT AT RATING AND VOLTAGE INDICATED

T' _d TRANSIENT TIME CONST.	0.12s
T'' _d SUB-TRANSTIME CONST.	0.016s
T' _{do} O.C. FIELD TIME CONST.	1.15s
T _a ARMATURE TIME CONST.	0.04s
SHORT CIRCUIT RATIO	1/X _d

**50
Hz**

HCI636K
Winding 312

STAMFORD

THREE PHASE EFFICIENCY CURVES

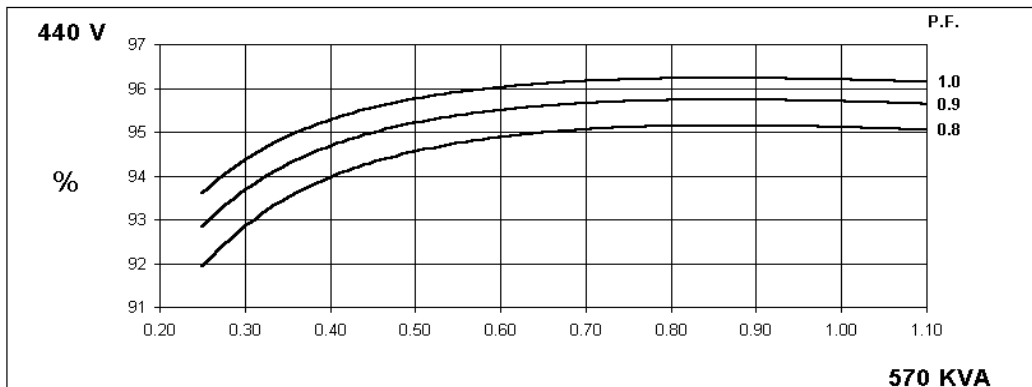
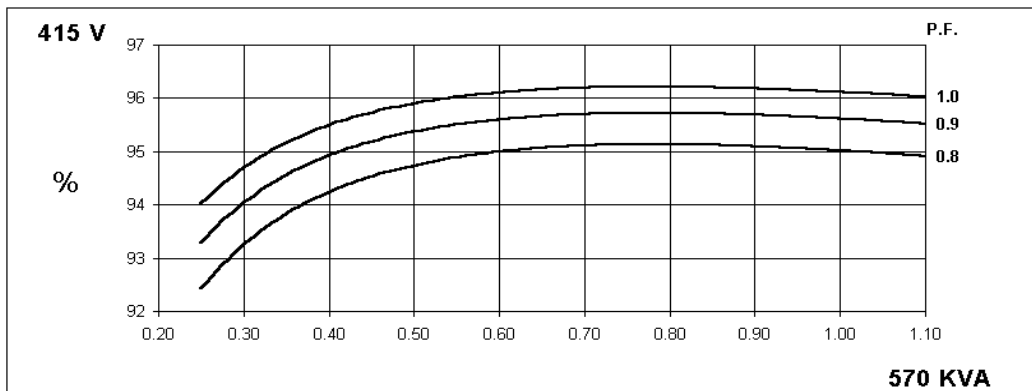
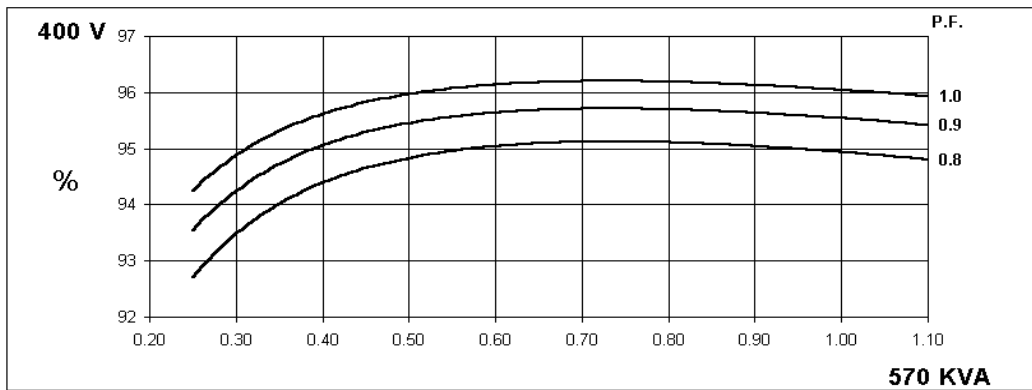
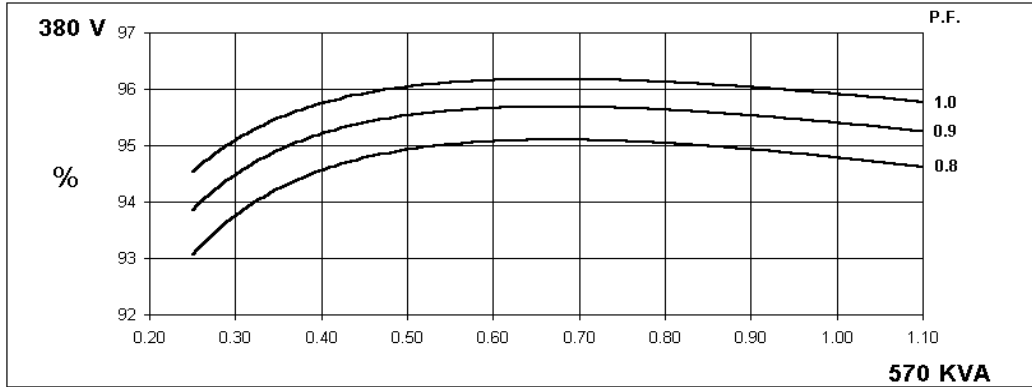

**60
Hz**

HCI636K
Winding 312

STAMFORD

THREE PHASE EFFICIENCY CURVES

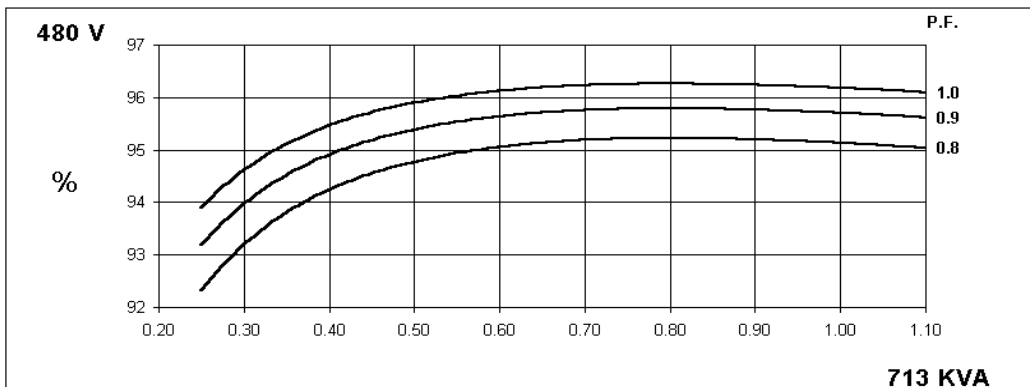
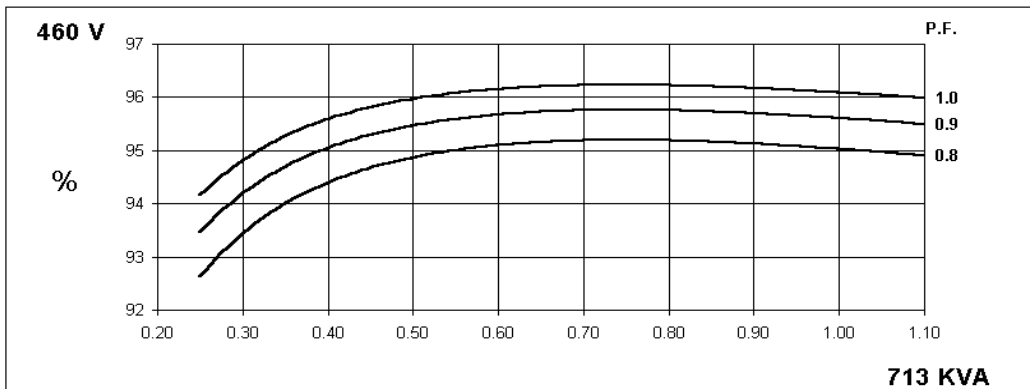
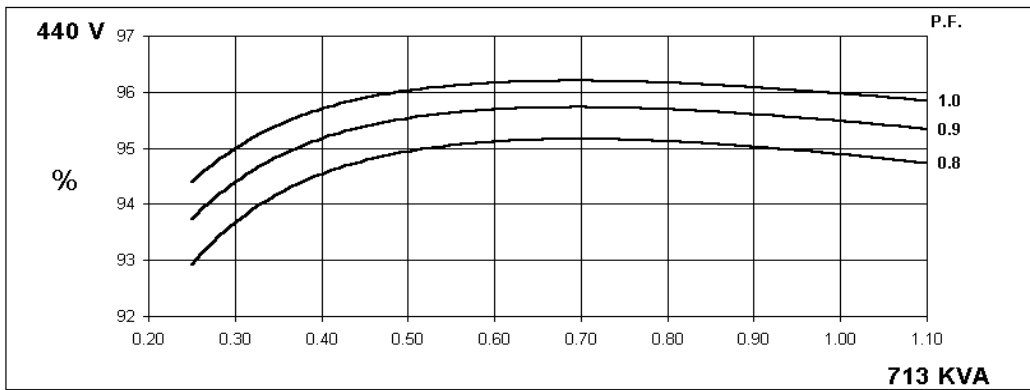
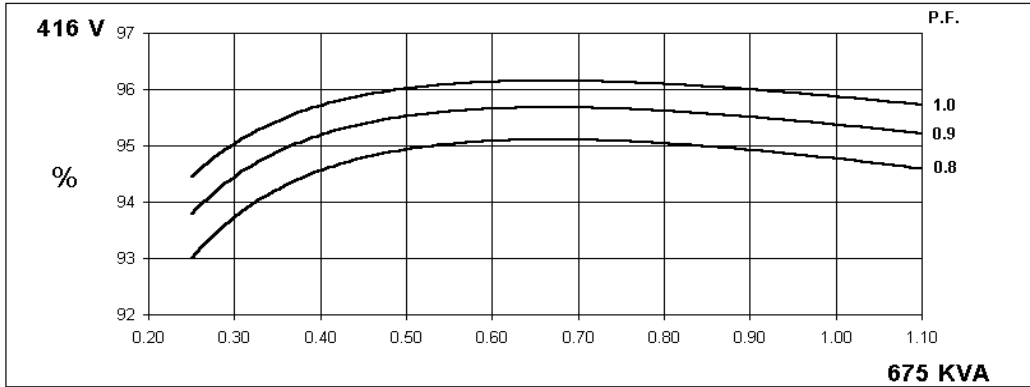

HCI636K
Winding 312

STAMFORD

Locked Rotor Motor Starting Curve

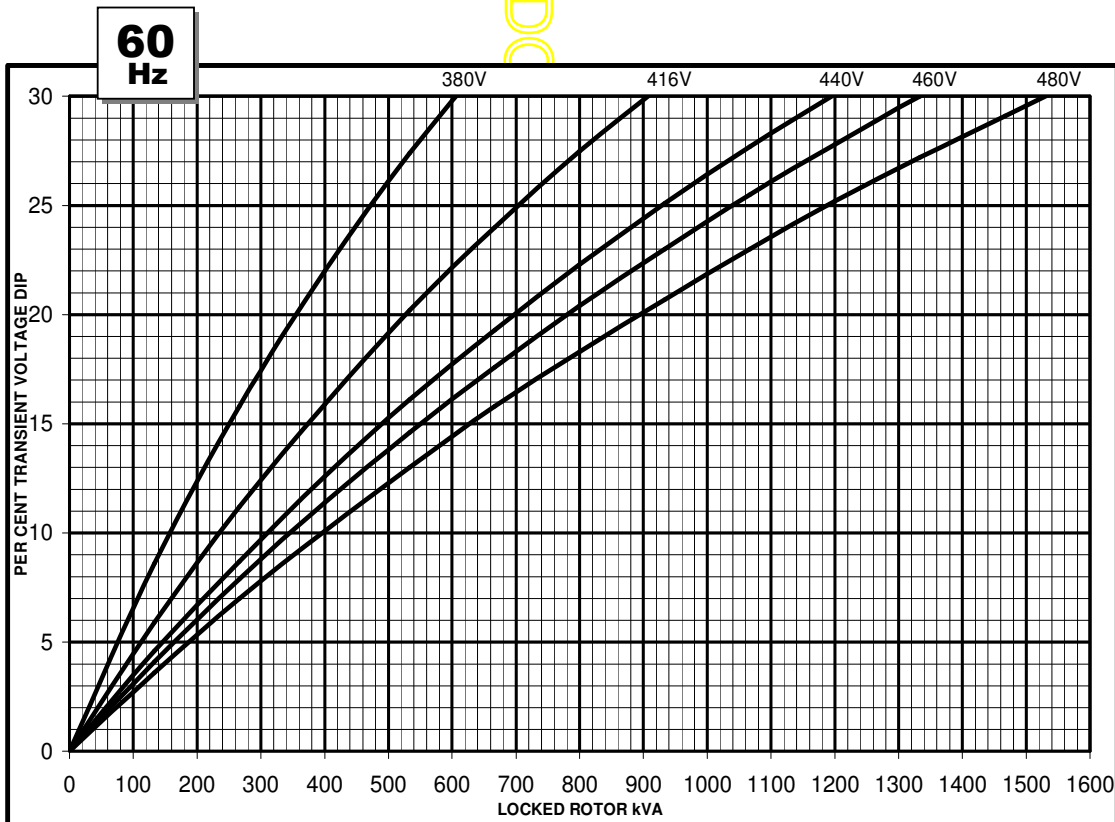

Three-phase Short Circuit Decrement Curve. No-load Excitation at Rated Speed
Based on star (wye) connection.

**50
Hz**

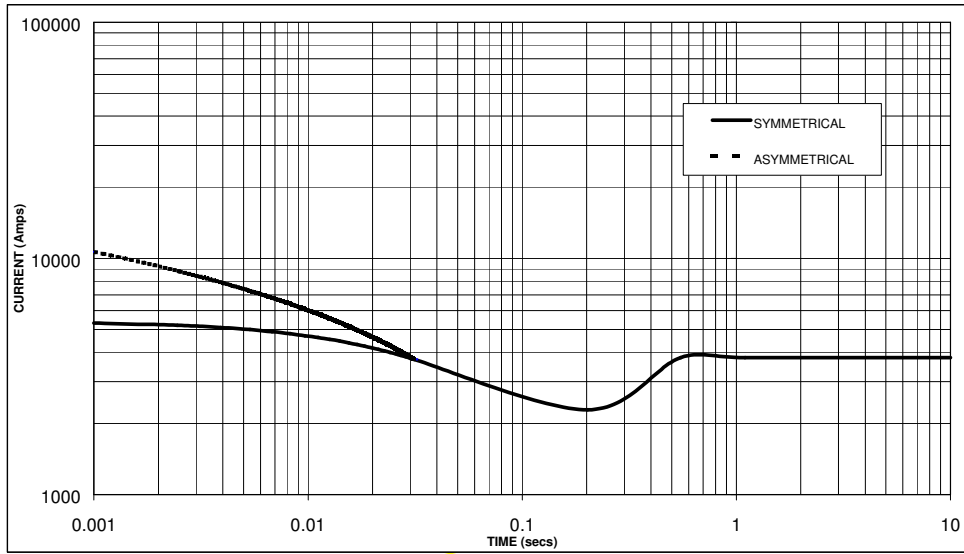

Sustained Short Circuit = 3,800 Amps



**60
Hz**

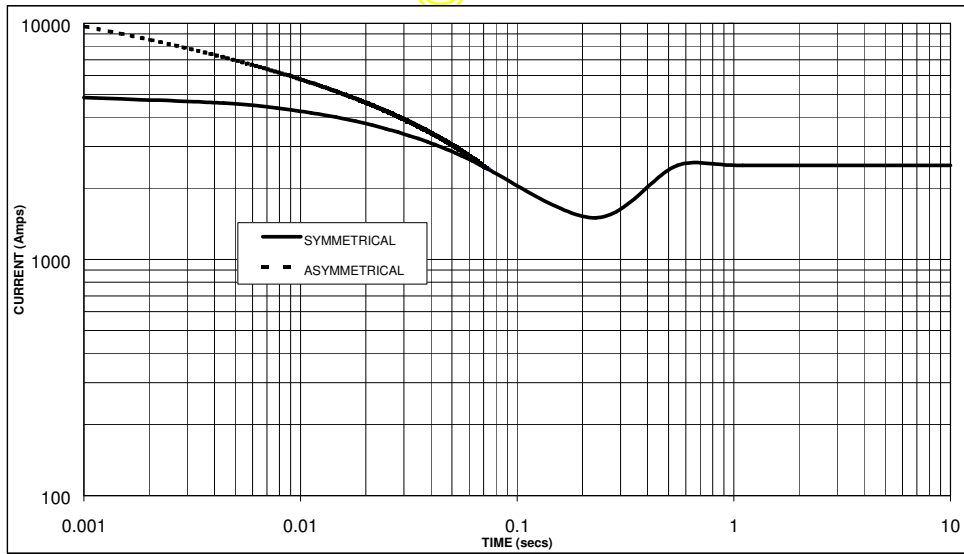

Sustained Short Circuit = 2,500 Amps

Note 1

The following multiplication factors should be used to adjust the values from curve between time 0.001 seconds and the minimum current point in respect of nominal operating voltage :

50Hz		60Hz	
Voltage	Factor	Voltage	Factor
380v	X 1.00	416v	x 1.00
400v	X 1.07	440v	x 1.06
415v	X 1.12	460v	x 1.12
440v	X 1.18	480v	x 1.17

The sustained current value is constant irrespective of voltage level

Note 2

The following multiplication factor should be used to convert the values calculated in accordance with NOTE 1 to those applicable to the various types of short circuit :

	3-phase	2-phase L-L	1-phase L-N
Instantaneous	x 1.00	x 0.87	x 1.30
Minimum	x 1.00	x 1.80	x 3.20
Sustained	x 1.00	x 1.50	x 2.50
Max. sustained duration	10 sec.	5 sec.	2 sec.

All other times are unchanged

Note 3

Curves are drawn for Star (Wye) connected machines. For Delta connection multiply the Curve current value by 1.732

HCI636K

STAMFORD

Winding 312 0.8 Power Factor

RATINGS

Class - Temp Rise		Cont. F - 105/40°C				Cont. H - 125/40°C				Standby - 150/40°C				Standby - 163/27°C			
50Hz	Star (V)	380	400	415	440	380	400	415	440	380	400	415	440	380	400	415	440
	Delta (V)	220	230	240	254	220	230	240	254	220	230	240	254	220	230	240	254
	kVA	525	525	525	525	570	570	570	570	593	593	593	593	610	610	610	610
	kW	420	420	420	420	456	456	456	456	474	474	474	474	488	488	488	488
	Efficiency (%)	94.9	95.0	95.1	95.1	94.8	94.9	95.0	95.1	94.7	94.9	95.0	95.1	94.7	94.8	94.9	95.1
	kW Input	443	442	442	442	481	481	480	479	501	500	499	499	515	515	514	513

60Hz	Star (V)	416	440	460	480	416	440	460	480	416	440	460	480	416	440	460	480
	Delta (V)	240	254	266	277	240	254	266	277	240	254	266	277	240	254	266	277
	kVA	625	656	656	656	675	713	713	713	702	742	742	742	722	763	763	763
	kW	500	525	525	525	540	570	570	570	562	594	594	594	578	610	610	610
	Efficiency (%)	94.9	95.0	95.1	95.2	94.8	94.9	95.0	95.1	94.7	94.8	95.0	95.1	94.7	94.8	94.9	95.1
	kW Input	527	552	552	551	570	601	600	600	593	626	625	624	610	644	643	642

DIMENSIONS

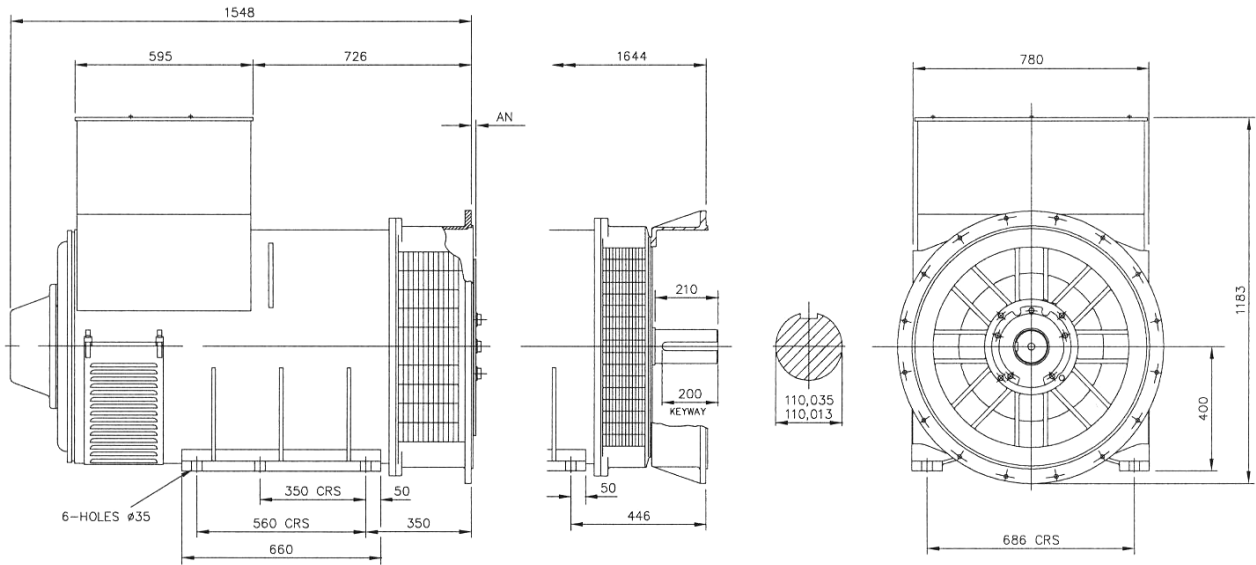

SAE	14	18	21	24
AN	25.4	15.87	0	0

APPROVED DOCUMENT

STAMFORD

Head Office Address:
Barnack Road, Stamford
Lincolnshire, PE9 2NB
United Kingdom
Tel: +44 (0) 1780 484000
Fax: +44 (0) 1780 484100

www.cumminsgeneratortechnologies.com

Copyright 2010, Cummins Generator Technologies Ltd, All Rights Reserved
Stamford and AvK are registered trade marks of Cummins Generator Technologies Ltd
Cummins and the Cummins logo are registered trade marks of Cummins Inc.