

STAMFORD[®]

HCI434D/444D - Winding 17

Technical  Data Sheet

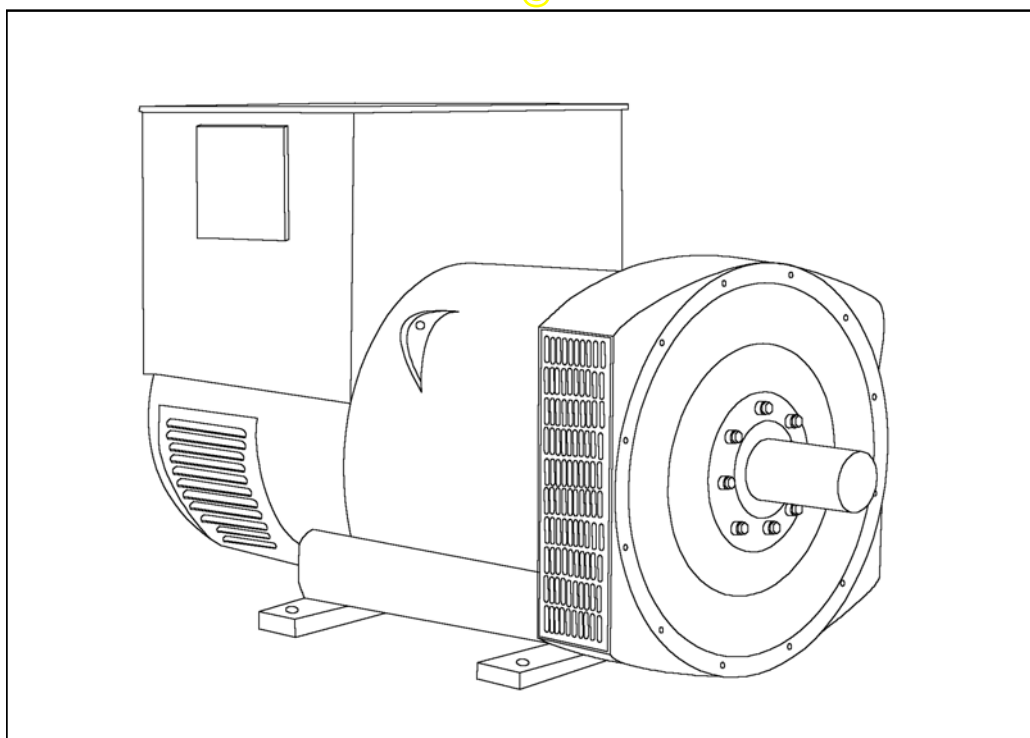

HCI434D/444D

SPECIFICATIONS & OPTIONS

STAMFORD

STANDARDS

Stamford industrial generators meet the requirements of BS EN 60034 and the relevant section of other international standards such as BS5000, VDE 0530, NEMA MG1-32, IEC34, CSA C22.2-100, AS1359. Other standards and certifications can be considered on request.

VOLTAGE REGULATORS

AS440 AVR - STANDARD

With this self-excited system the main stator provides power via the Automatic Voltage Regulator (AVR) to the exciter stator. The high efficiency semi-conductors of the AVR ensure positive build-up from initial low levels of residual voltage.

The exciter rotor output is fed to the main rotor through a three-phase full-wave bridge rectifier. The rectifier is protected by a surge suppressor against surges caused, for example, by short circuit or out-of-phase paralleling.

The AS440 will support a range of electronic accessories, including a 'droop' Current Transformer (CT) to permit parallel operation with other ac generators.

MX341 AVR

This sophisticated AVR is incorporated into the Stamford Permanent Magnet Generator (PMG) control system.

The PMG provides power via the AVR to the main exciter, giving a source of constant excitation power independent of generator output. The main exciter output is then fed to the main rotor, through a full wave bridge, protected by a surge suppressor. The AVR has in-built protection against sustained over-excitation, caused by internal or external faults. This de-excites the machine after a minimum of 5 seconds.

An engine relief load acceptance feature can enable full load to be applied to the generator in a single step.

If three-phase sensing is required with the PMG system the MX321 AVR must be used.

We recommend three-phase sensing for applications with greatly unbalanced or highly non-linear loads.

MX321 AVR

The most sophisticated of all our AVRs combines all the features of the MX341 with, additionally, three-phase rms sensing, for improved regulation and performance.

Over voltage protection is built-in and short circuit current level adjustments is an optional facility.

WINDINGS & ELECTRICAL PERFORMANCE

All generator stators are wound to 2/3 pitch. This eliminates triplen (3rd, 9th, 15th ...) harmonics on the voltage waveform and is found to be the optimum design for trouble-free supply of non-linear loads. The 2/3 pitch design avoids excessive neutral currents sometimes seen with higher winding pitches, when in parallel with the mains. A fully connected damper winding reduces oscillations during paralleling. This winding, with the 2/3 pitch and carefully selected pole and tooth designs, ensures very low waveform distortion.

TERMINALS & TERMINAL BOX

Standard generators are 3-phase reconnectable with 12 ends brought out to the terminals, which are mounted on a cover at the non-drive end of the generator. A sheet steel terminal box contains the AVR and provides ample space for the customers' wiring and gland arrangements. It has removable panels for easy access.

SHAFT & KEYS

All generator rotors are dynamically balanced to better than BS6861:Part 1 Grade 2.5 for minimum vibration in operation. Two bearing generators are balanced with a half key.

INSULATION/IMPREGNATION

The insulation system is class 'H'.

All wound components are impregnated with materials and processes designed specifically to provide the high build required for static windings and the high mechanical strength required for rotating components.

QUALITY ASSURANCE

Generators are manufactured using production procedures having a quality assurance level to BS EN ISO 9001.

The stated voltage regulation may not be maintained in the presence of certain radio transmitted signals. Any change in performance will fall within the limits of Criteria 'B' of EN 61000-6-2:2001. At no time will the steady-state voltage regulation exceed 2%.

DE RATES

All values tabulated on page 6 are subject to the following reductions

5% when air inlet filters are fitted.

3% for every 500 metres by which the operating altitude exceeds 1000 metres above mean sea level.

3% for every 5 C by which the operational ambient temperature exceeds 40 C.

Note: Requirement for operating in an ambient exceeding 60 C must be referred to the factory.

NB Continuous development of our products entitles us to change specification details without notice, therefore they must not be regarded as binding.

Front cover drawing typical of product range.

APPROVED DOCUMENT

HCI434D/444D

STAMFORD

WINDING 17

CONTROL SYSTEM	SEPARATELY EXCITED BY P.M.G.		
A.V.R.	MX321	MX341	
VOLTAGE REGULATION	± 0.5 %	± 1.0 %	With 4% ENGINE GOVERNING
SUSTAINED SHORT CIRCUIT	REFER TO SHORT CIRCUIT DECREMENT CURVES (page 5)		
CONTROL SYSTEM	SELF EXCITED		
A.V.R.	AS440		
VOLTAGE REGULATION	± 1.0 %		With 4% ENGINE GOVERNING
SUSTAINED SHORT CIRCUIT	WILL NOT SUSTAIN A SHORT CIRCUIT		
INSULATION SYSTEM	CLASS H		
PROTECTION	IP23		
RATED POWER FACTOR	0.8		
STATOR WINDING	DOUBLE LAYER LAP		
WINDING PITCH	TWO THIRDS		
WINDING LEADS	12		
STATOR WDG. RESISTANCE	0.02 Ohms PER PHASE AT 22°C SERIES STAR CONNECTED		
ROTOR WDG. RESISTANCE	1.05 Ohms at 22°C		
EXCITER STATOR RESISTANCE	18 Ohms at 22°C		
EXCITER ROTOR RESISTANCE	0.068 Ohms PER PHASE AT 22°C		
R.F.I. SUPPRESSION	BS EN 61000-6-2 & BS EN 61000-6-4, VDE 0875G, VDE 0875N. refer to factory for others		
WAVEFORM DISTORTION	NO LOAD < 1.5% NON-DISTORTING BALANCED LINEAR LOAD < 5.0%		
MAXIMUM OVERSPEED	2250 Rev/Min		
BEARING DRIVE END	BALL. 6317 (ISO)		
BEARING NON-DRIVE END	BALL. 6314 (ISO)		
	1 BEARING	2 BEARING	
WEIGHT COMP. GENERATOR	940 kg	950 kg	
WEIGHT WOUND STATOR	415 kg	415 kg	
WEIGHT WOUND ROTOR	361 kg	338 kg	
WR ² INERTIA	4.0771 kgm ²	3.8783 kgm ²	
SHIPPING WEIGHTS in a crate	1010 kg	1010 kg	
PACKING CRATE SIZE	155 x 87 x 107(cm)	155 x 87 x 107(cm)	
TELEPHONE INTERFERENCE	THF<2%	TIF<50	
COOLING AIR	0.99 m ³ /sec 2100 cfm		
VOLTAGE SERIES STAR	600V		
VOLTAGE PARALLEL STAR	300V		
VOLTAGE SERIES DELTA	346V		
KVA BASE RATING FOR REACTANCE VALUES	375		
X _d DIR. AXIS SYNCHRONOUS	2.96		
X' _d DIR. AXIS TRANSIENT	0.18		
X'' _d DIR. AXIS SUBTRANSIENT	0.13		
X _q QUAD. AXIS REACTANCE	2.54		
X'' _q QUAD. AXIS SUBTRANSIENT	0.34		
X _L LEAKAGE REACTANCE	0.07		
X ₂ NEGATIVE SEQUENCE	0.22		
X ₀ ZERO SEQUENCE	0.08		
REACTANCES ARE SATURATED		VALUES ARE PER UNIT AT RATING AND VOLTAGE INDICATED	
T' _d TRANSIENT TIME CONST.	0.08s		
T'' _d SUB-TRANSTIME CONST.	0.019s		
T' _{do} O.C. FIELD TIME CONST.	1.7s		
T _a ARMATURE TIME CONST.	0.018s		
SHORT CIRCUIT RATIO	1/X _d		

HCI434D/444D

STAMFORD

Winding 17

SX

Locked Rotor Motor Starting Curves

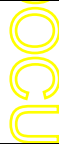
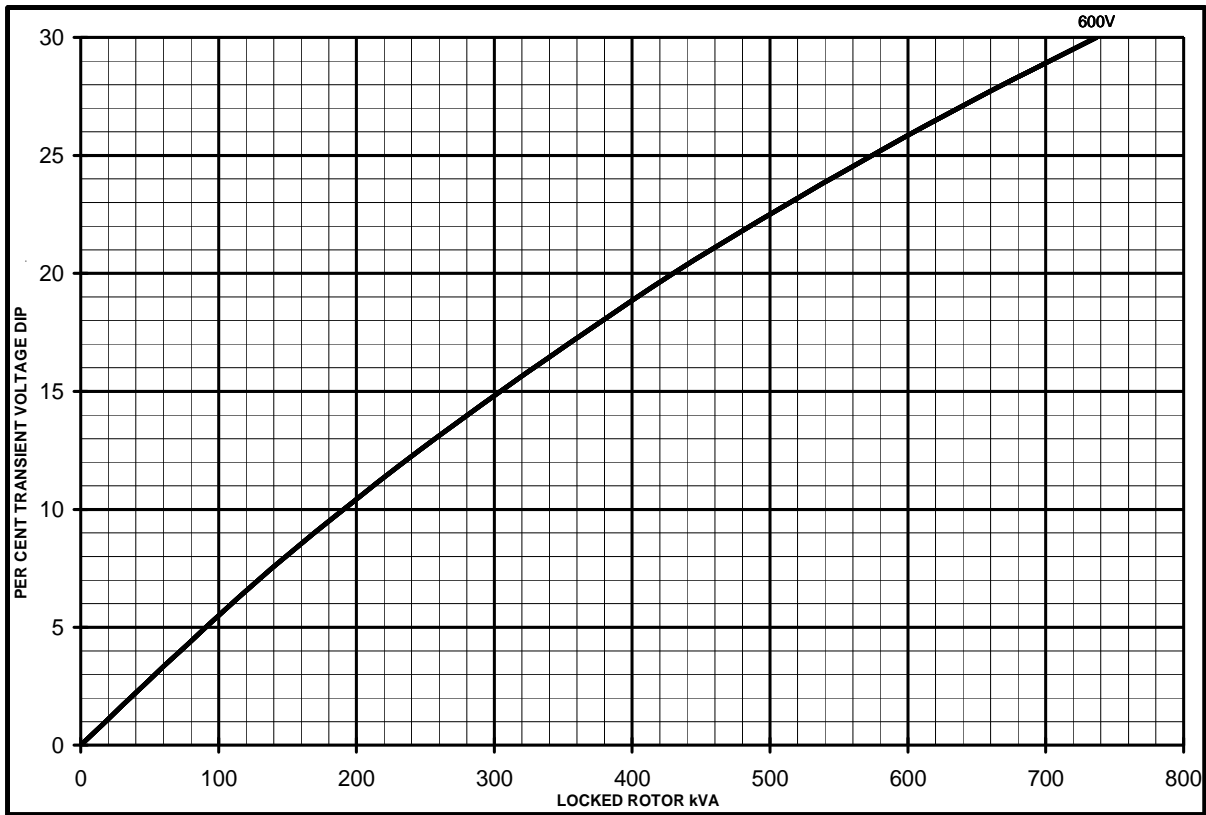

MX

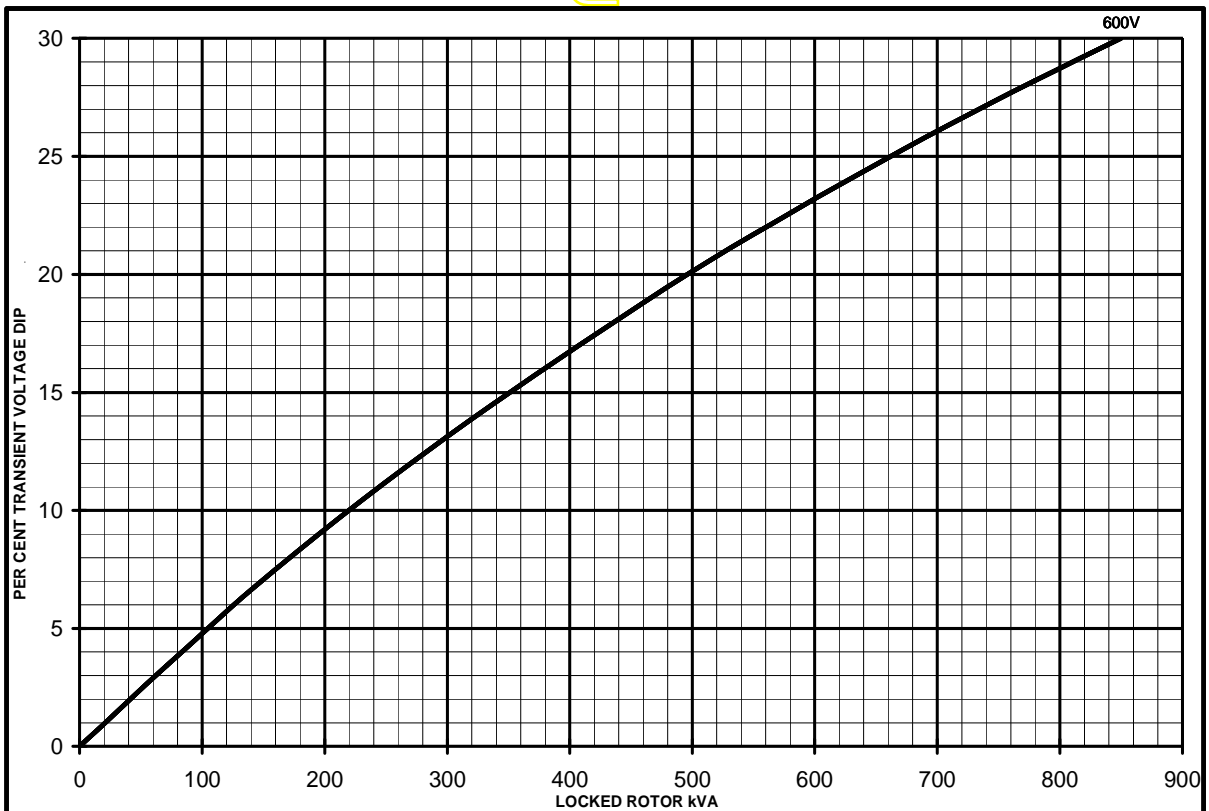

HCI434D/444D
Winding 17

STAMFORD

THREE PHASE EFFICIENCY CURVES

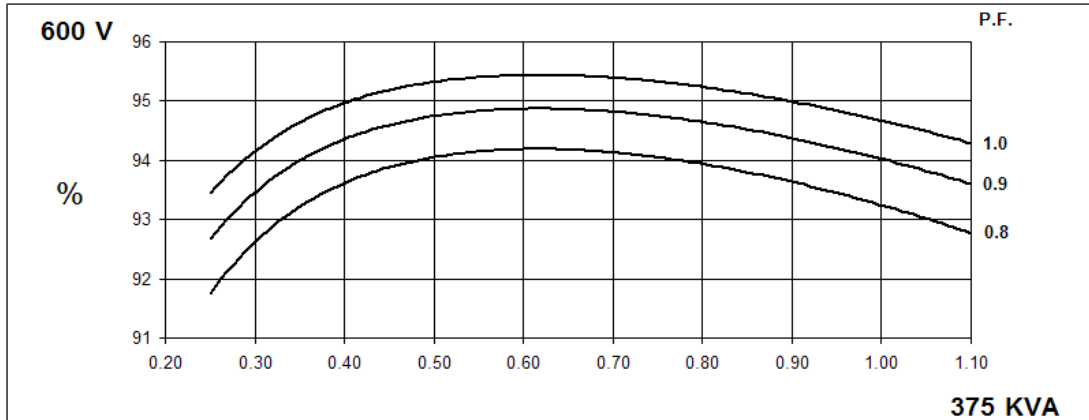

Three-phase Short Circuit Decrement Curve. No-load Excitation at Rated Speed Based on star (wye) connection.

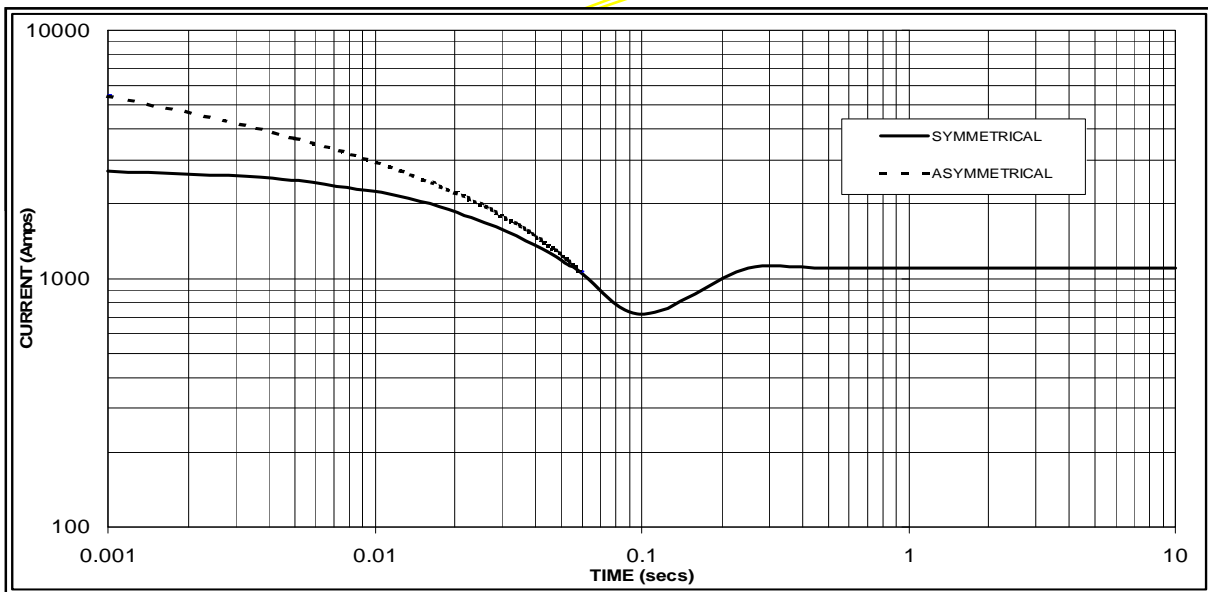

Sustained Short Circuit = 1100 Amps

Note

The following multiplication factor should be used to convert the values from curve for the various types of short circuit :

	3-phase	2-phase L-L	1-phase L-N
Instantaneous	x 1.00	x 0.87	x 1.30
Minimum	x 1.00	x 1.80	x 3.20
Sustained	x 1.00	x 1.50	x 2.50
Max. sustained duration	10 sec.	5 sec.	2 sec.

All other times are unchanged

HCI434D/444D

Winding 17 / 0.8 Power Factor

STAMFORD

60Hz

RATINGS

Class - Temp Rise	Cont. F - 105/40°C	Cont. H - 125/40°C	Standby - 150/40°C	Standby - 163/27°C
Series Star (V)	600	600	600	600
Parallel Star (V)	300	300	300	300
Series Delta (V)	346	346	346	346
kVA	345	375	400	415
kW	276	300	320	332
Efficiency (%)	93.6	93.2	92.9	92.7
kW Input	295	322	344	358

APPROXIMATE

DIMENSIONS

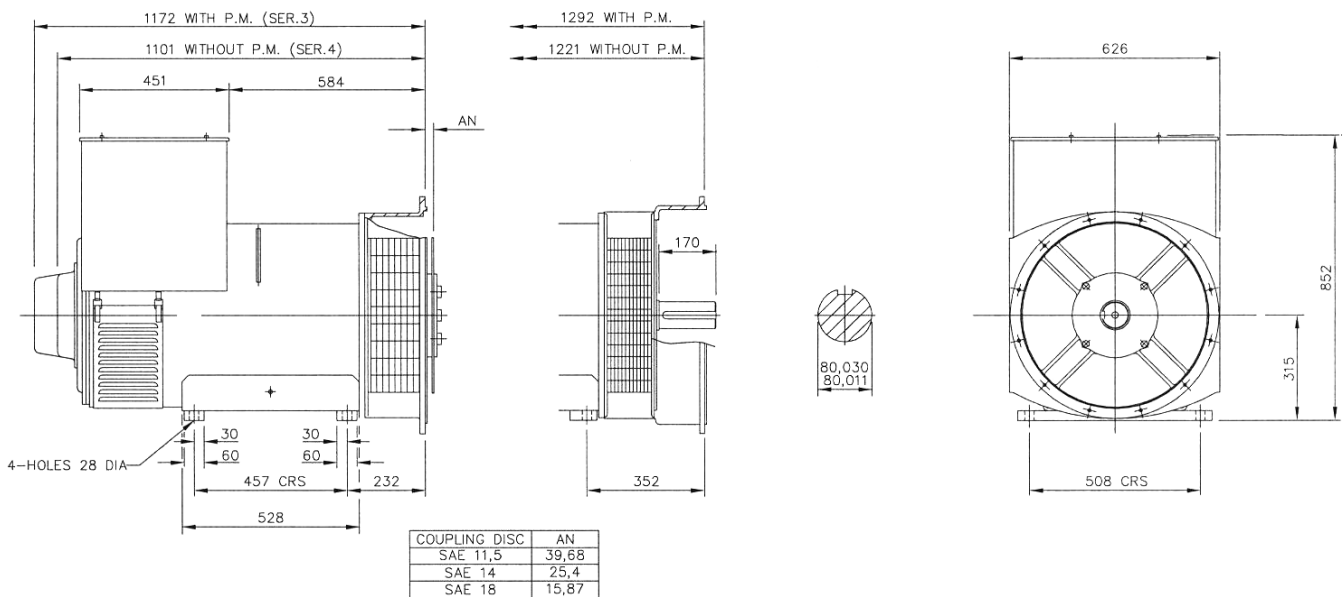

APPROVED DOCUMENT

STAMFORD

Head Office Address:
Barnack Road, Stamford
Lincolnshire, PE9 2NB
United Kingdom
Tel: +44 (0) 1780 484000
Fax: +44 (0) 1780 484100

www.cumminsgeneratortechnologies.com

Copyright 2010, Cummins Generator Technologies Ltd, All Rights Reserved
Stamford and AvK are registered trade marks of Cummins Generator Technologies Ltd
Cummins and the Cummins logo are registered trade marks of Cummins Inc.