

STAMFORD[®]

UCDI274K - Winding 311

Technical Data Sheet

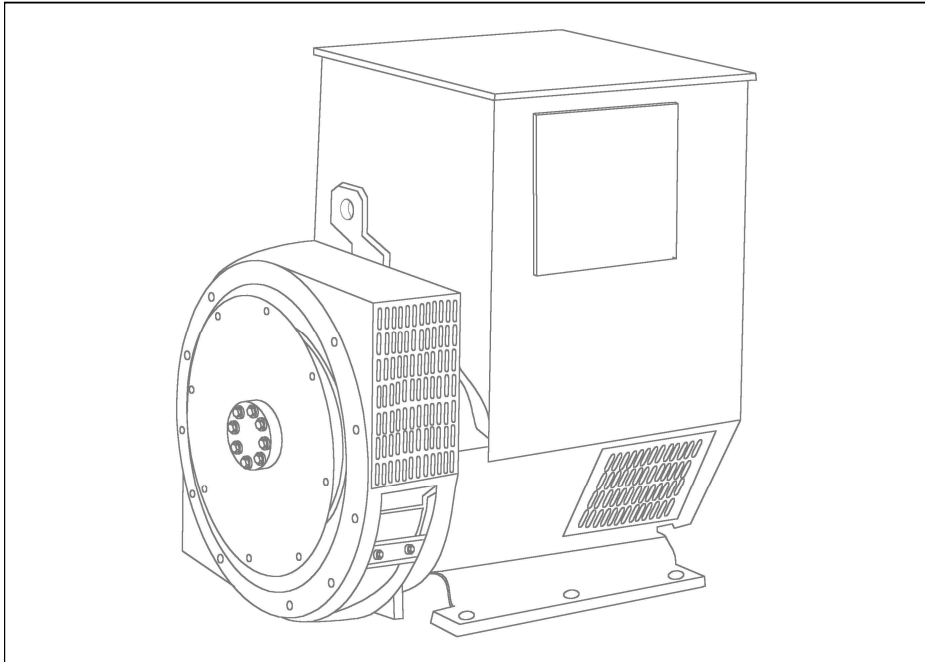

SPECIFICATIONS & OPTIONS**STANDARDS**

Stamford industrial generators meet the requirements of BS EN 60034 and the relevant section of other international standards such as BS5000, VDE 0530, NEMA MG1-32, IEC34, CSA C22.2-100, AS1359.

Other standards and certifications can be considered on request.

VOLTAGE REGULATORS**SX460 AVR - OBSOLETE**

With this self excited control system the main stator supplies power via the Automatic Voltage Regulator (AVR) to the exciter stator. The high efficiency semiconductors of the AVR ensure positive build-up from initial low levels of residual voltage.

The exciter rotor output is fed to the main rotor through a three phase full wave bridge rectifier. This rectifier is protected by a surge suppressor against surges caused, for example, by short circuit.

AS440 AVR - STANDARD

With this self-excited system the main stator provides power via the AVR to the exciter stator. The high efficiency semiconductors of the AVR ensure positive build-up from initial low levels of residual voltage.

The exciter rotor output is fed to the main rotor through a three-phase full-wave bridge rectifier. The rectifier is protected by a surge suppressor against surges caused, for example, by short circuit or out-of-phase paralleling.

The AS440 will support a range of electronic accessories, including a 'droop' Current Transformer (CT) to permit parallel operation with other ac generators.

MX341 AVR

This sophisticated AVR is incorporated into the Stamford Permanent Magnet Generator (PMG) control system.

The PMG provides power via the AVR to the main exciter, giving a source of constant excitation power independent of generator output. The main exciter output is then fed to the main rotor, through a full wave bridge, protected by a surge suppressor. The AVR has in-built protection against sustained over-excitation, caused by internal or external faults. This de-excites the machine after a minimum of 5 seconds.

An engine relief load acceptance feature can enable full load to be applied to the generator in a single step.

If three-phase sensing is required with the PMG system the MX321 AVR must be used.

We recommend three-phase sensing for applications with greatly unbalanced or highly non-linear loads.

MX321 AVR

The most sophisticated of all our AVRs combines all the features of the MX341 with, additionally, three-phase rms sensing, for improved regulation and performance.

Over voltage protection is built-in and short circuit current level adjustments is an optional facility.

WINDINGS & ELECTRICAL PERFORMANCE

All generator stators are wound to 2/3 pitch. This eliminates triplen (3rd, 9th, 15th ...) harmonics on the voltage waveform and is found to be the optimum design for trouble-free supply of non-linear loads. The 2/3 pitch design avoids excessive neutral currents sometimes seen with higher winding pitches, when in parallel with the mains. A fully connected damper winding reduces oscillations during paralleling. This winding, with the 2/3 pitch and carefully selected pole and tooth designs, ensures very low waveform distortion.

TERMINALS & TERMINAL BOX

Standard generators are 3-phase reconnectable with 12 ends brought out to the terminals, which are mounted on a cover at the non-drive end of the generator. A sheet steel terminal box contains the AVR and provides ample space for the customers' wiring and gland arrangements. It has removable panels for easy access.

SHAFT & KEYS

All generator rotors are dynamically balanced to better than BS6861:Part 1 Grade 2.5 for minimum vibration in operation.

INSULATION/IMPREGNATION

The insulation system is class 'H'.

All wound components are impregnated with materials and processes designed specifically to provide the high build required for static windings and the high mechanical strength required for rotating components.

QUALITY ASSURANCE

Generators are manufactured using production procedures having a quality assurance level to BS EN ISO 9001.

The stated voltage regulation may not be maintained in the presence of certain radio transmitted signals. Any change in performance will fall within the limits of Criteria 'B' of EN 61000-6-2:2001. At no time will the steady-state voltage regulation exceed 2%.

DE RATES

All values tabulated on page 8 are subject to the following reductions

5% when air inlet filters are fitted.

3% for every 500 metres by which the operating altitude exceeds 1000 metres above mean sea level.

3% for every 5°C by which the operational ambient temperature exceeds 40°C.

Note: Requirement for operating in an ambient exceeding 60°C must be referred to the factory.

NB Continuous development of our products entitles us to change specification details without notice, therefore they must not be regarded as binding.

Front cover drawing typical of product range.

UCDI274K



WINDING 311

CONTROL SYSTEM	SEPARATELY EXCITED BY P.M.G.							
A.V.R.	MX321	MX341						
VOLTAGE REGULATION	± 0.5 %	± 1.0 %	With 4% ENGINE GOVERNING					
SUSTAINED SHORT CIRCUIT	REFER TO SHORT CIRCUIT DECREMENT CURVES (page 7)							
CONTROL SYSTEM	SELF EXCITED							
A.V.R.	SX460	AS440						
VOLTAGE REGULATION	± 1.0 %	± 1.0 %	With 4% ENGINE GOVERNING					
SUSTAINED SHORT CIRCUIT	SERIES 4 CONTROL DOES NOT SUSTAIN A SHORT CIRCUIT CURRENT							
INSULATION SYSTEM	CLASS H							
PROTECTION	IP23							
RATED POWER FACTOR	0.8							
STATOR WINDING	DOUBLE LAYER CONCENTRIC							
WINDING PITCH	TWO THIRDS							
WINDING LEADS	12							
STATOR WDG. RESISTANCE	0.0126 Ohms PER PHASE AT 22°C SERIES STAR CONNECTED							
ROTOR WDG. RESISTANCE	2.08 Ohms at 22°C							
EXCITER STATOR RESISTANCE	20 Ohms at 22°C							
EXCITER ROTOR RESISTANCE	0.091 Ohms PER PHASE AT 22°C							
R.F.I. SUPPRESSION	BS EN 61000-6-2 & BS EN 61000-6-4, VDE 0875G, VDE 0875N. refer to factory for others							
WAVEFORM DISTORTION	NO LOAD < 1.5% NON-DISTORTING BALANCED LINEAR LOAD < 5.0%							
MAXIMUM OVERSPEED	2250 Rev/Min							
BEARING NON-DRIVE END	BALL. 6310-2RS (ISO)							
WEIGHT COMP. GENERATOR	727 kg							
WEIGHT WOUND STATOR	304 kg							
WEIGHT WOUND ROTOR	272.6 kg							
WR ² INERTIA	2.3934 kgm ²							
SHIPPING WEIGHTS in a crate	740 kg							
PACKING CRATE SIZE	123 x 67 x 103 (cm)							
	50 Hz				60 Hz			
TELEPHONE INTERFERENCE	THF<2%				TIF<50			
COOLING AIR	0.58 m ³ /sec 1230 cfm				0.69 m ³ /sec 1463 cfm			
VOLTAGE SERIES STAR (Y)	380/220	400/231	415/240	440/254	416/240	440/254	460/266	480/277
VOLTAGE PARALLEL STAR (Y)	190/110	200/115	208/120	220/127	208/120	220/127	230/133	240/138
VOLTAGE SERIES DELTA	220/110	230/115	240/120	254/127	240/120	254/127	266/133	277/138
KVA BASE RATING FOR REACTANCE VALUES	250	250	250	N/A	291	299	312.5	312.5
X _d DIR. AXIS SYNCHRONOUS	2.825	2.550	2.369	-	3.161	2.903	2.776	2.550
X' _d DIR. AXIS TRANSIENT	0.132	0.119	0.111	-	0.148	0.136	0.130	0.119
X'' _d DIR. AXIS SUBTRANSIENT	0.086	0.078	0.072	-	0.097	0.089	0.085	0.078
X _q QUAD. AXIS REACTANCE	1.263	1.140	1.059	-	1.413	1.298	1.241	1.140
X'' _q QUAD. AXIS SUBTRANSIENT	0.152	0.137	0.127	-	0.170	0.156	0.149	0.137
X _L LEAKAGE REACTANCE	0.066	0.060	0.056	-	0.074	0.068	0.065	0.060
X ₂ NEGATIVE SEQUENCE	0.120	0.108	0.100	-	0.134	0.123	0.118	0.108
X ₀ ZERO SEQUENCE	0.022	0.020	0.019	-	0.025	0.023	0.022	0.020
REACTANCES ARE SATURATED				VALUES ARE PER UNIT AT RATING AND VOLTAGE INDICATED				
T' _d TRANSIENT TIME CONST.	0.049 s							
T'' _d SUB-TRANSTIME CONST.	0.02 s							
T' _{do} O.C. FIELD TIME CONST.	1.27 s							
T _a ARMATURE TIME CONST.	0.018 s							
SHORT CIRCUIT RATIO	1/X _d							

**50
Hz**

UCDI274K
Winding 311

STAMFORD

THREE PHASE EFFICIENCY CURVES

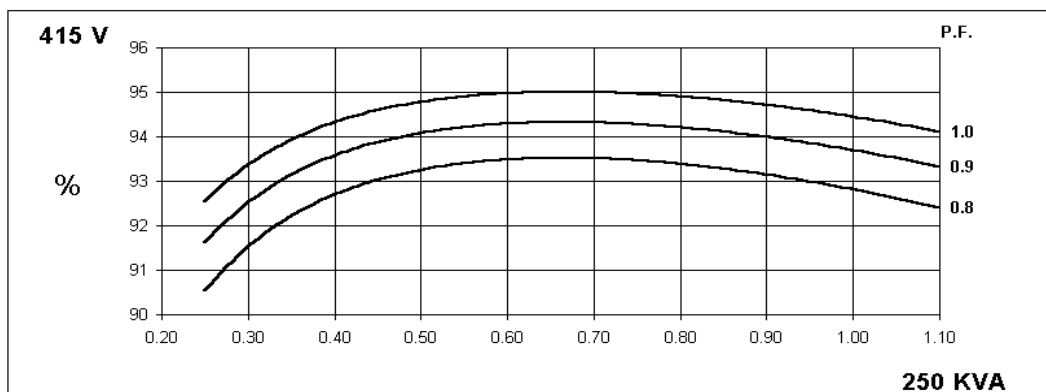
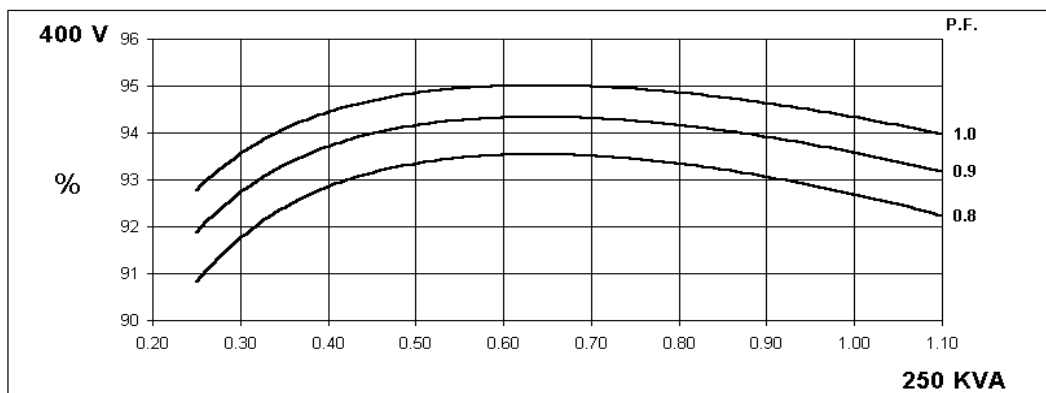
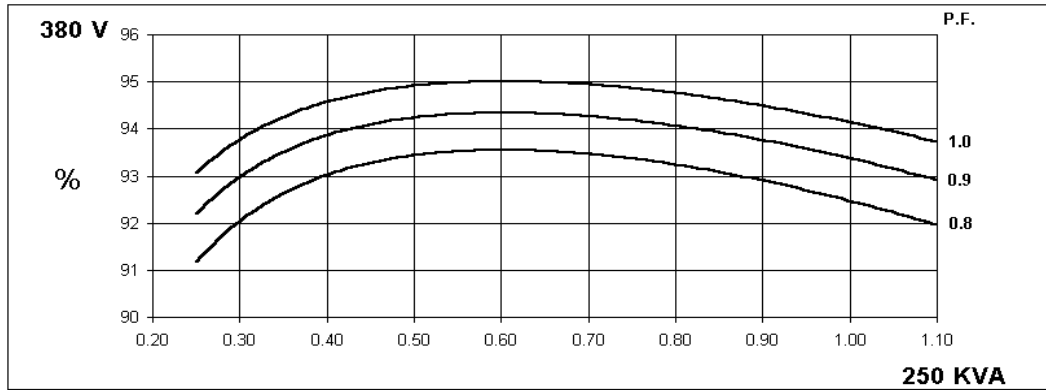

**60
Hz**

UCDI274K
Winding 311

STAMFORD

THREE PHASE EFFICIENCY CURVES

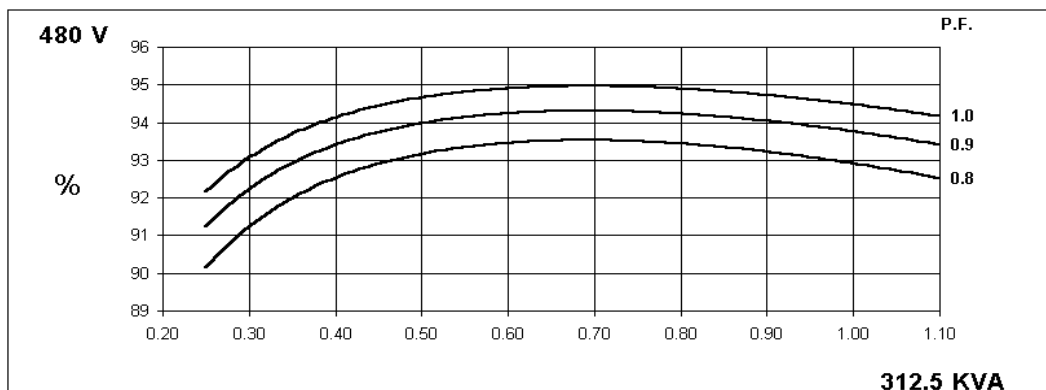
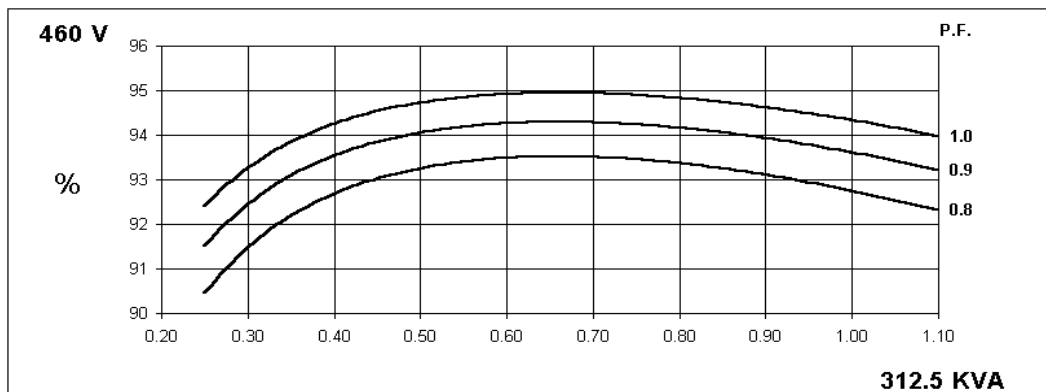
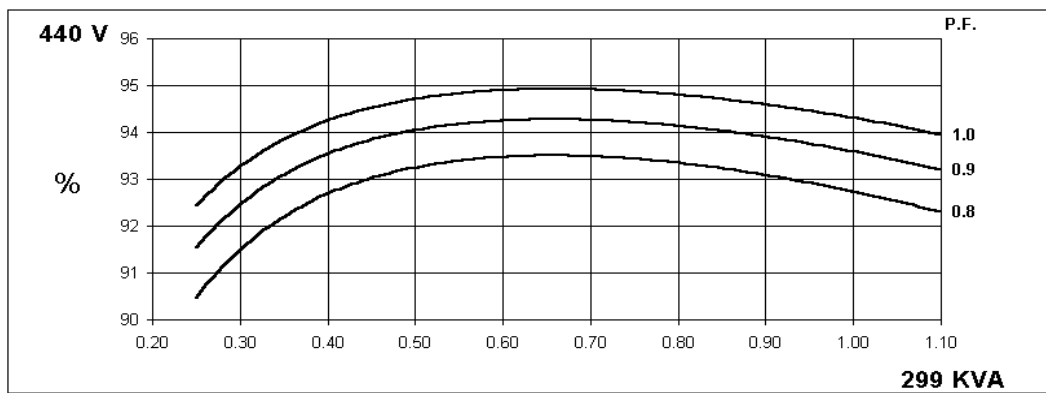
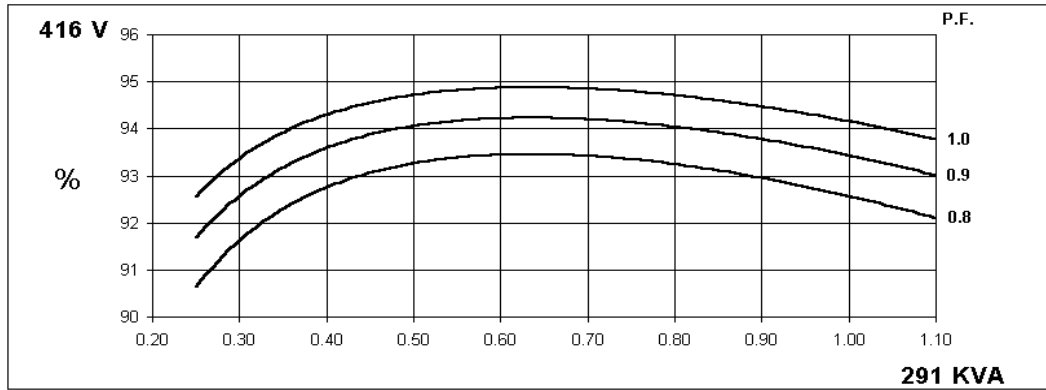

Locked Rotor Motor Starting Curve

50 Hz

MX

SX

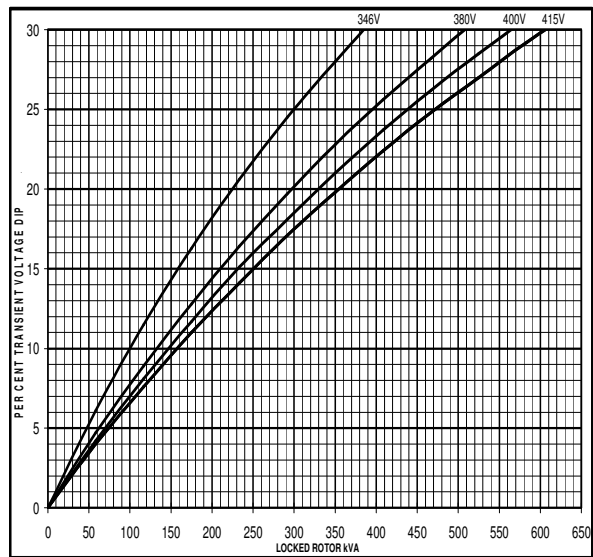
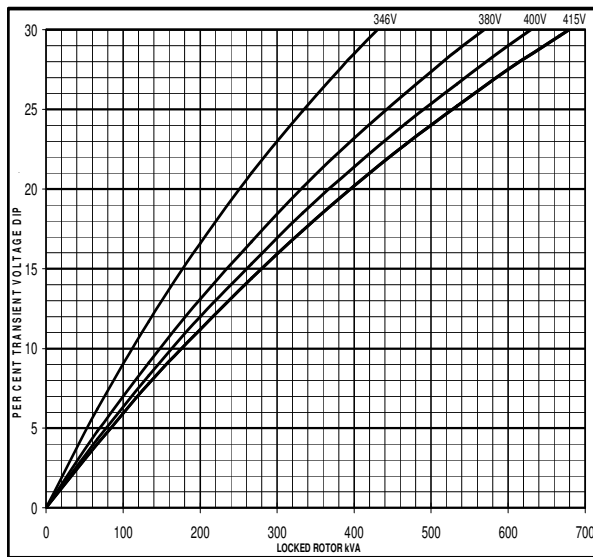

60 Hz

MX

SX

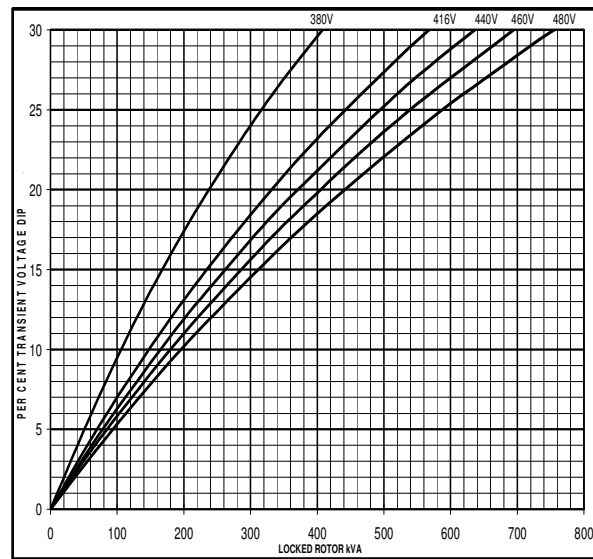
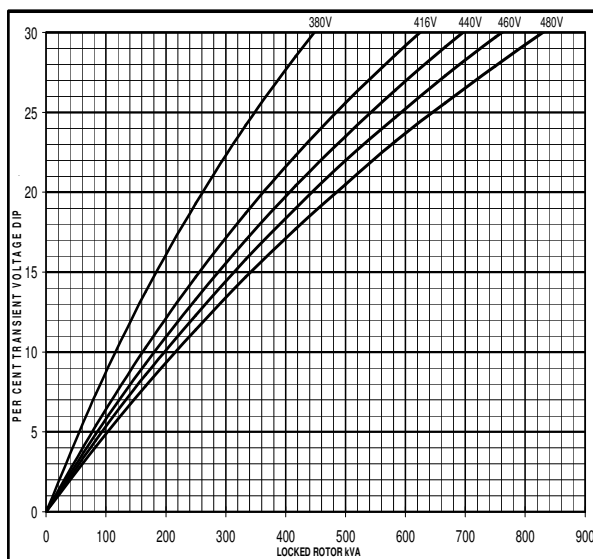

Three-phase Short Circuit Decrement Curve. No-load Excitation at Rated Speed
Based on star (wye) connection.

**50
Hz**

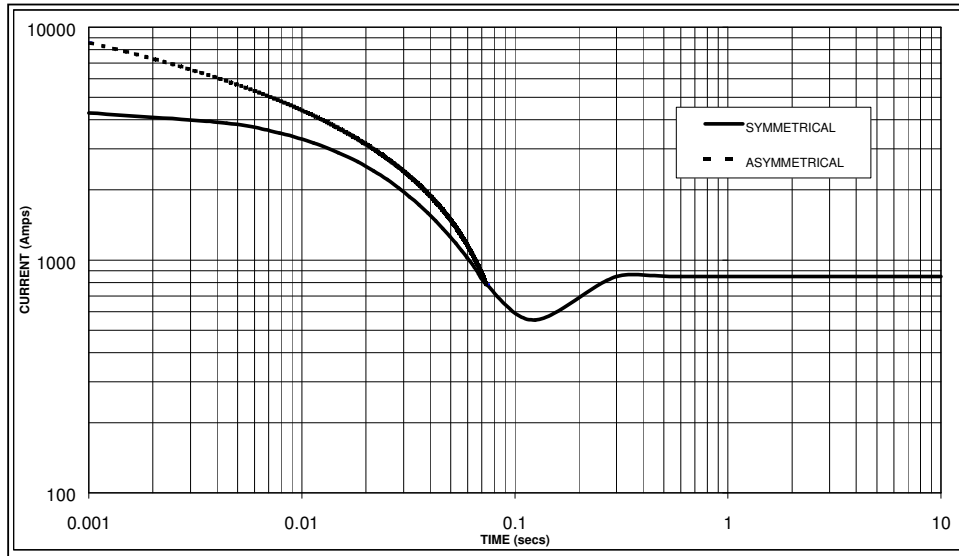

Sustained Short Circuit = 850 Amps

**60
Hz**

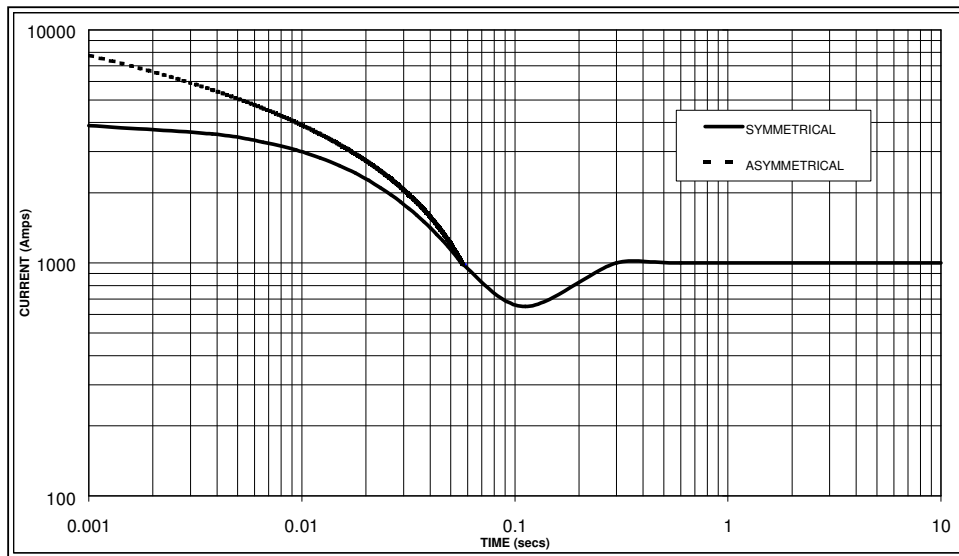

Sustained Short Circuit = 1,000 Amps

Note 1

The following multiplication factors should be used to adjust the values from curve between time 0.001 seconds and the minimum current point in respect of nominal operating voltage :

50Hz		60Hz	
Voltage	Factor	Voltage	Factor
380v	X 1.00	416v	X 1.00
400v	X 1.05	440v	X 1.07
415v	X 1.10	460v	X 1.12
		480v	X 1.16

The sustained current value is constant irrespective of voltage level

This alternator is capable of achieving a balanced 300% sustained short circuit for up to 10 seconds.

Note 2

The following multiplication factor should be used to convert the values calculated in accordance with NOTE 1 to those applicable to the various types of short circuit :

	3-phase	2-phase L-L	1-phase L-N
Instantaneous	x 1.00	x 0.87	x 1.30
Minimum	x 1.00	x 1.80	x 3.20
Sustained	x 1.00	x 1.50	x 2.50
Max. sustained duration	10 sec.	5 sec.	2 sec.

All other times are unchanged

Note 3

Curves are drawn for Star (Wye) connected machines. For other connection the following multipliers should be applied to current values as shown :

Parallel Star = Curve current value X 2

Series Delta = Curve current value X 1.732

UCDI274K

STAMFORD

Winding 311 / 0.8 Power Factor

RATINGS

Class - Temp Rise		Cont. F - 105/40°C				Cont. H - 125/40°C				Standby - 150/40°C				Standby - 163/27°C			
50 Hz	Series Star (V)	380	400	415	440	380	400	415	440	380	400	415	440	380	400	415	440
	Parallel Star (V)	190	200	208	220	190	200	208	220	190	200	208	220	190	200	208	220
	Series Delta (V)	220	230	240	254	220	230	240	254	220	230	240	254	220	230	240	254
	kVA	229.0	229.0	229.0	N/A	250.0	250.0	250.0	N/A	265.0	265.0	265.0	N/A	275.0	275.0	275.0	N/A
	kW	183.2	183.2	183.2	N/A	200.0	200.0	200.0	N/A	212.0	212.0	212.0	N/A	220.0	220.0	220.0	N/A
	Efficiency (%)	92.8	93.0	93.1	N/A	92.5	92.7	92.8	N/A	92.2	92.4	92.6	N/A	92.0	92.2	92.4	N/A
	kW Input	197.4	197.0	196.8	N/A	216.2	215.7	215.5	N/A	229.9	229.4	228.9	N/A	239.1	238.6	238.1	N/A
60 Hz	Series Star (V)	416	440	460	480	416	440	460	480	416	440	460	480	416	440	460	480
	Parallel Star (V)	208	220	230	240	208	220	230	240	208	220	230	240	208	220	230	240
	Series Delta (V)	240	254	266	277	240	254	266	277	240	254	266	277	240	254	266	277
	kVA	267.0	275.0	286.5	288.0	291.0	299.0	312.5	312.5	304.0	312.5	331.3	331.3	312.0	320.0	343.8	343.8
	kW	213.6	220.0	229.2	230.4	232.8	239.2	250.0	250.0	243.2	250.0	265.0	265.0	249.6	256.0	275.0	275.0
	Efficiency (%)	92.9	93.0	93.1	93.2	92.6	92.7	92.8	92.9	92.4	92.6	92.5	92.7	92.2	92.4	92.3	92.5
	kW Input	229.9	236.6	246.2	247.3	251.4	258.0	269.4	269.1	263.2	270.0	286.5	285.9	270.7	277.1	298.0	297.3

Dimensional and Torsional Drawing

For dimensional and torsional information please refer to the alternator General Arrangement and rotor drawings available on our website (<http://stamford-avk.com/>)

STAMFORD

www.stamford-avk.com

Copyright 2022, Cummins Generator Technologies Ltd, All Rights Reserved
Stamford and AvK are registered trade marks of Cummins Generator Technologies Ltd
Cummins and the Cummins logo are registered trade marks of Cummins Inc.