

STAMFORD[®]

HCI434F/444F - Winding 311 Single Phase

Technical  Data Sheet

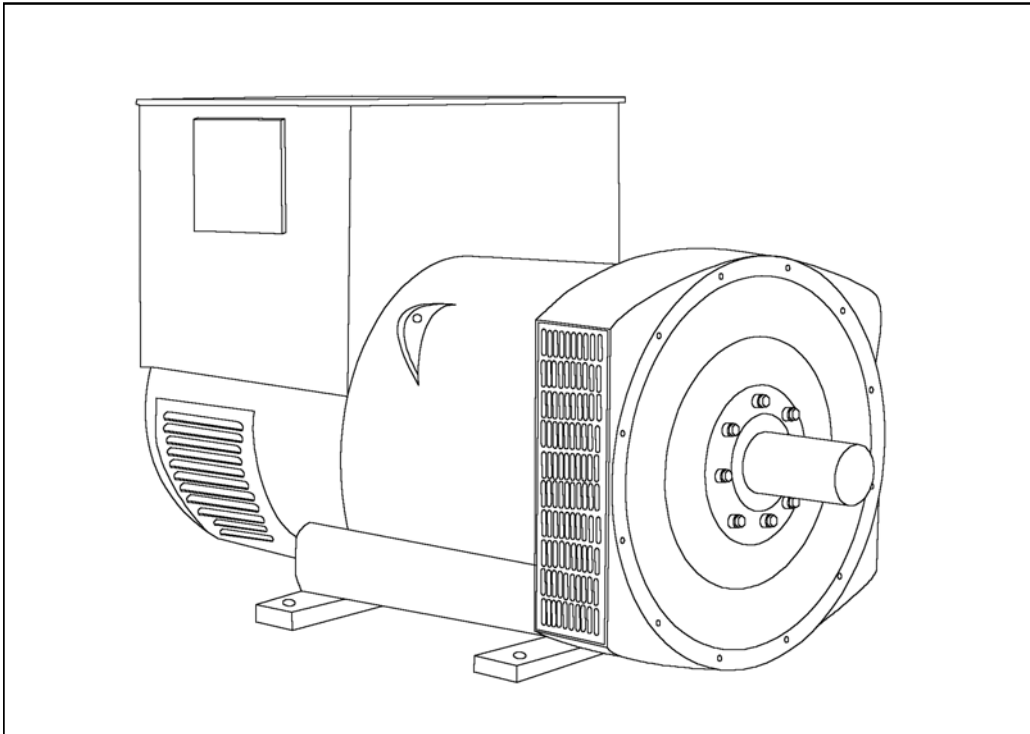

HCI434F/444F

SPECIFICATIONS & OPTIONS

STAMFORD

STANDARDS

Stamford industrial generators meet the requirements of BS EN 60034 and the relevant section of other international standards such as BS5000, VDE 0530, NEMA MG1-32, IEC34, CSA C22.2-100, AS1359. Other standards and certifications can be considered on request.

VOLTAGE REGULATORS

SX460 AVR - STANDARD

With this self excited control system the main stator supplies power via the Automatic Voltage Regulator (AVR) to the exciter stator. The high efficiency semiconductors of the AVR ensure positive build-up from initial low levels of residual voltage.

The exciter rotor output is fed to the main rotor through a three phase full wave bridge rectifier. This rectifier is protected by a surge suppressor against surges caused, for example, by short circuit.

AS440 AVR

With this self-excited system the main stator provides power via the AVR to the exciter stator. The high efficiency semi-conductors of the AVR ensure positive build-up from initial low levels of residual voltage.

The exciter rotor output is fed to the main rotor through a three-phase full-wave bridge rectifier. The rectifier is protected by a surge suppressor against surges caused, for example, by short circuit or out-of-phase paralleling.

The AS440 will support a range of electronic accessories, including a 'droop' Current Transformer (CT) to permit parallel operation with other ac generators.

MX341 AVR

This sophisticated AVR is incorporated into the Stamford Permanent Magnet Generator (PMG) control system.

The PMG provides power via the AVR to the main exciter, giving a source of constant excitation power independent of generator output. The main exciter output is then fed to the main rotor, through a full wave bridge, protected by a surge suppressor. The AVR has in-built protection against sustained over-excitation, caused by internal or external faults. This de-excites the machine after a minimum of 5 seconds.

An engine relief load acceptance feature can enable full load to be applied to the generator in a single step.

MX321 AVR

The most sophisticated of all our AVRs combines all the features of the MX341 with, additionally, over voltage protection built-in and short circuit current level adjustments as an optional facility.

WINDINGS & ELECTRICAL PERFORMANCE

All generator stators are wound to 2/3 pitch. This eliminates triplen (3rd, 9th, 15th ...) harmonics on the voltage waveform and is found to be the optimum design for trouble-free supply of non-linear loads. The 2/3 pitch design avoids excessive neutral currents sometimes seen with higher winding pitches, when in parallel with the mains. A fully connected damper winding reduces oscillations during paralleling. This winding, with the 2/3 pitch and carefully selected pole and tooth designs, ensures very low waveform distortion.

TERMINALS & TERMINAL BOX

Standard generators are reconnectable with 12 ends brought out to the terminals, which are mounted on a cover at the non-drive end of the generator. A sheet steel terminal box contains the AVR and provides ample space for the customers' wiring and gland arrangements. It has removable panels for easy access.

SHAFT & KEYS

All generator rotors are dynamically balanced to better than BS6861:Part 1 Grade 2.5 for minimum vibration in operation. Two bearing generators are balanced with a half key.

INSULATION/IMPREGNATION

The insulation system is class 'H'.

All wound components are impregnated with materials and processes designed specifically to provide the high build required for static windings and the high mechanical strength required for rotating components.

QUALITY ASSURANCE

Generators are manufactured using production procedures having a quality assurance level to BS EN ISO 9001.

The stated voltage regulation may not be maintained in the presence of certain radio transmitted signals. Any change in performance will fall within the limits of Criteria 'B' of EN 61000-6-2:2001. At no time will the steady-state voltage regulation exceed 2%.

DE RATES

All values tabulated on page 8 are subject to the following reductions

5% when air inlet filters are fitted.

3% for every 500 metres by which the operating altitude exceeds 1000 metres above mean sea level.

3% for every 5 C by which the operational ambient temperature exceeds 40 C.

Note: Requirement for operating in an ambient exceeding 60 C must be referred to the factory.

NB Continuous development of our products entitles us to change specification details without notice, therefore they must not be regarded as binding.

Front cover drawing typical of product range.

APPROVED DOCUMENT

HCI434F/444F



WINDING 311 Single Phase

CONTROL SYSTEM	SEPARATELY EXCITED BY P.M.G.		
A.V.R.	MX341	MX321	
VOLTAGE REGULATION	± 1%	± 0.5 %	With 4% ENGINE GOVERNING
SUSTAINED SHORT CIRCUIT	REFER TO SHORT CIRCUIT DECREMENT CURVES (page 7)		

CONTROL SYSTEM	SELF EXCITED		
A.V.R.	AS440		
VOLTAGE REGULATION	± 1.0 %	With 4% ENGINE GOVERNING	
SUSTAINED SHORT CIRCUIT	WILL NOT SUSTAIN A SHORT CIRCUIT		

INSULATION SYSTEM	CLASS H					
PROTECTION	IP23					
RATED POWER FACTOR	0.8					
STATOR WINDING	DOUBLE LAYER LAP					
WINDING PITCH	TWO THIRDS					
WINDING LEADS	12					
STATOR WDG. RESISTANCE	0.005 Ohms AT 22°C DOUBLE DELTA CONNECTED					
ROTOR WDG. RESISTANCE	1.37 Ohms at 22°C					
EXCITER STATOR RESISTANCE	18 Ohms at 22°C					
EXCITER ROTOR RESISTANCE	0.068 Ohms PER PHASE AT 22°C					
R.F.I. SUPPRESSION	BS EN 61000-6-2 & BS EN 61000-6-4, VDE 0875G, VDE 0875N. refer to factory for others					
WAVEFORM DISTORTION	NO LOAD < 1.5% NON-DISTORTING LINEAR LOAD < 5.0%					
MAXIMUM OVERSPEED	2250 Rev/Min					
BEARING DRIVE END	BALL. 6317 (ISO)					
BEARING NON-DRIVE END	BALL. 6314 (ISO)					
	1 BEARING			2 BEARING		
WEIGHT COMP. GENERATOR	1160 kg			1160 kg		
WEIGHT WOUND STATOR	535 kg			535 kg		
WEIGHT WOUND ROTOR	463 kg			440 kg		
WR ² INERTIA	5.4292 kgm ²			5.2304 kgm ²		
SHIPPING WEIGHTS in a crate	1230 kg			1230 kg		
PACKING CRATE SIZE	155 x 87 x 107(cm)			155 x 87 x 107(cm)		
	50 Hz			60 Hz		
TELEPHONE INTERFERENCE	THF<2%			TIF<50		
COOLING AIR	0.8 m ³ /sec 1700 cfm			0.99 m ³ /sec 2100 cfm		
VOLTAGE DOUBLE DELTA	220/110	230/115	240/120	220/110	230/115	240/120
VOLTAGE PARALLEL DELTA	110	115	120	110	115	120
KVA BASE RATING FOR REACTANCE VALUES	200	200	200	210	220	230
X _d DIR. AXIS SYNCHRONOUS	2.02	1.85	1.70	2.69	2.58	2.47
X' _d DIR. AXIS TRANSIENT	0.13	0.12	0.11	0.15	0.14	0.14
X'' _d DIR. AXIS SUBTRANSIENT	0.10	0.09	0.08	0.11	0.10	0.10
X _q QUAD. AXIS REACTANCE	1.75	1.60	1.47	2.38	2.28	2.19
X'' _q QUAD. AXIS SUBTRANSIENT	0.23	0.21	0.19	0.35	0.34	0.32
X _L LEAKAGE REACTANCE	0.04	0.04	0.04	0.06	0.06	0.05
X ₂ NEGATIVE SEQUENCE	0.17	0.15	0.14	0.24	0.23	0.22
X ₀ ZERO SEQUENCE	0.06	0.06	0.05	0.08	0.08	0.08
REACTANCES ARE SATURATED VALUES ARE PER UNIT AT RATING AND VOLTAGE INDICATED						
T' _d TRANSIENT TIME CONST.	0.08 s					
T'' _d SUB-TRANSTIME CONST.	0.019 s					
T' _{do} O.C. FIELD TIME CONST.	1.7 s					
T _a ARMATURE TIME CONST.	0.018 s					
SHORT CIRCUIT RATIO	1/X _d					

50
Hz

HCI434F/444F
Winding 311 Single Phase

STAMFORD

SINGLE PHASE EFFICIENCY CURVES

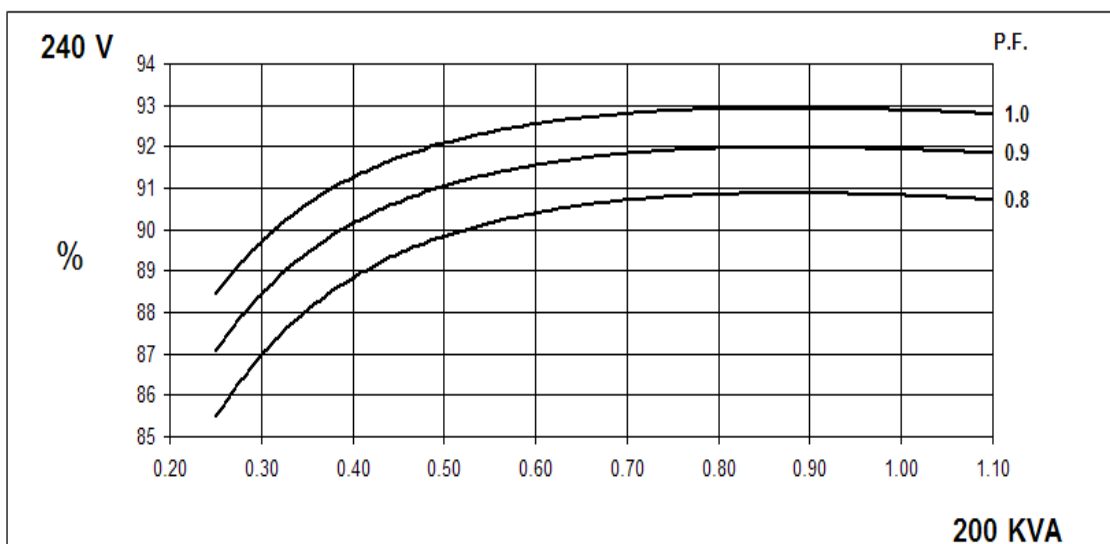
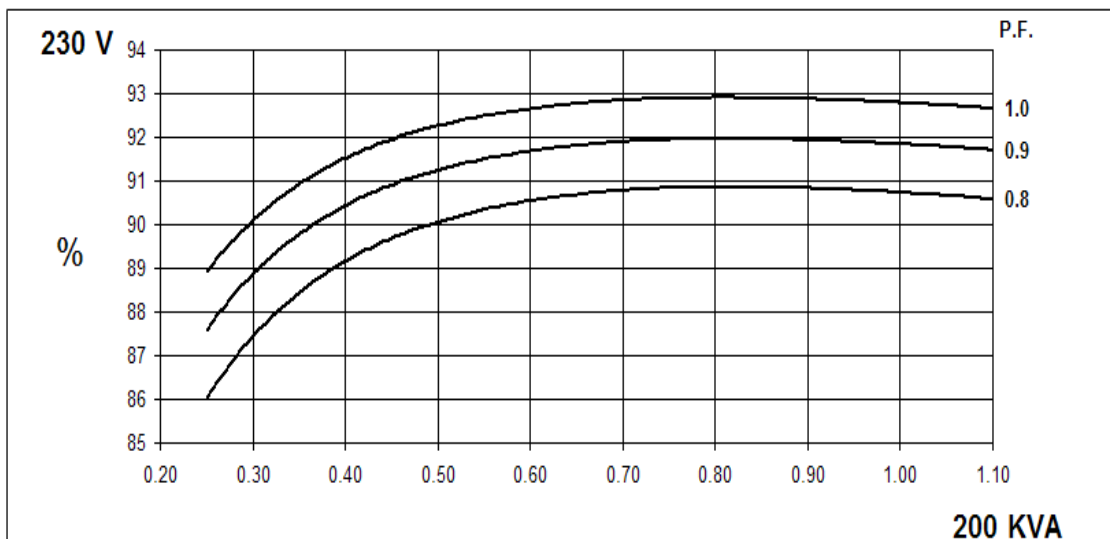
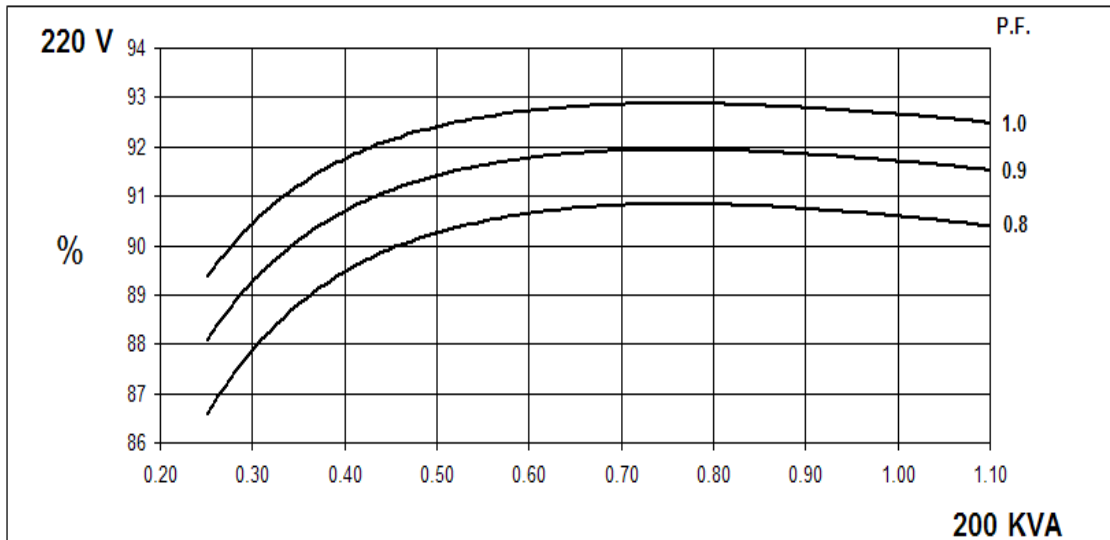

60
Hz

HCI434F/444F
Winding 311 Single Phase

STAMFORD

SINGLE PHASE EFFICIENCY CURVES

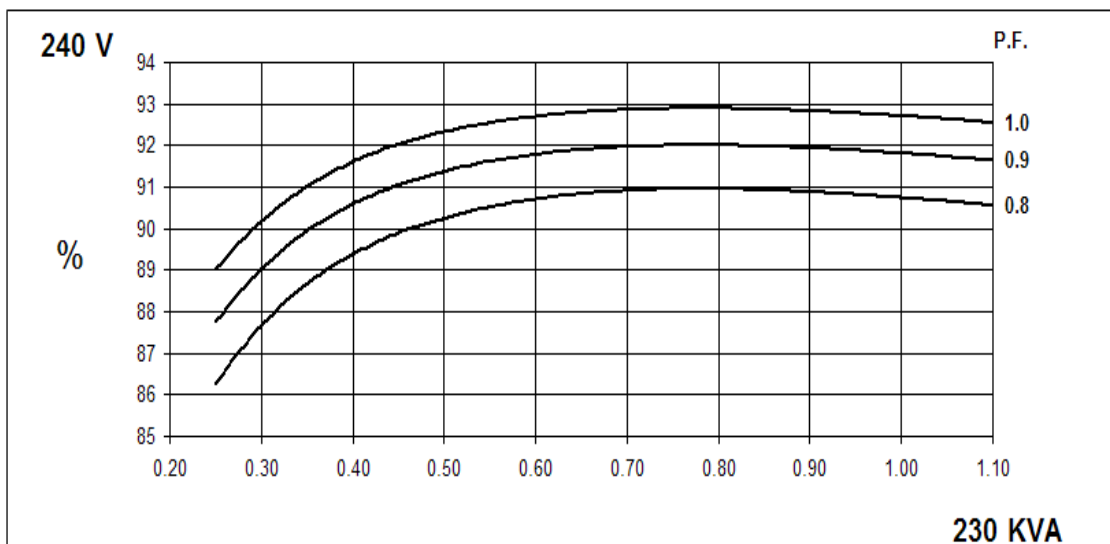
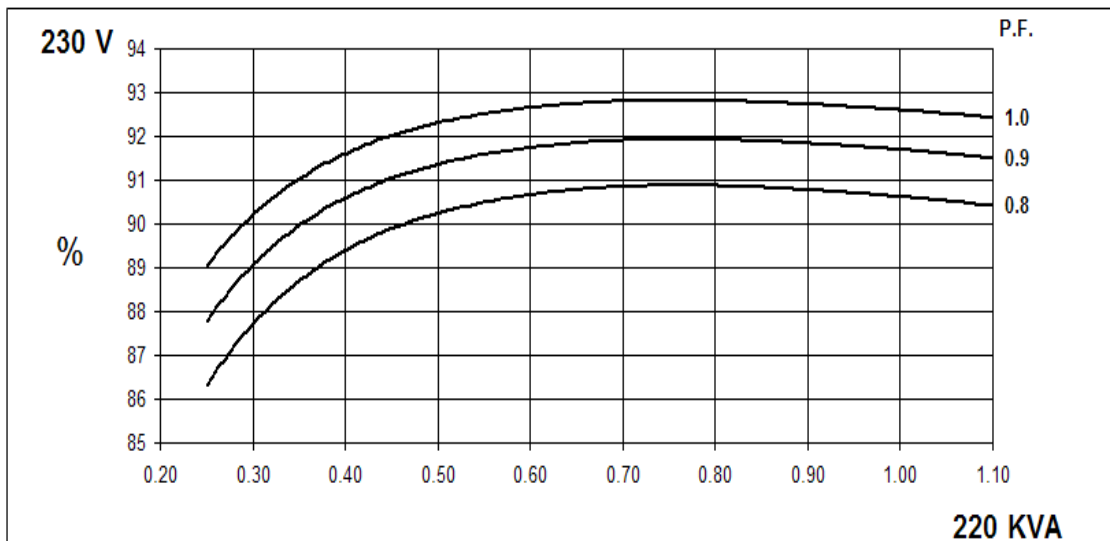
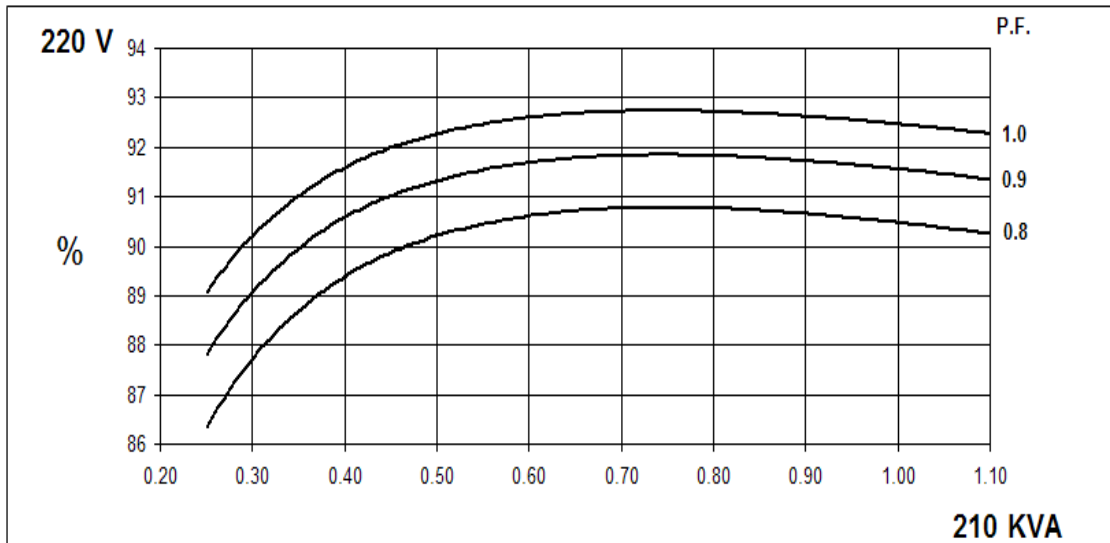

HCI434F/444F

STAMFORD

Winding 311 Single Phase

Locked Rotor Motor Starting Curve

50
Hz

MX

SX

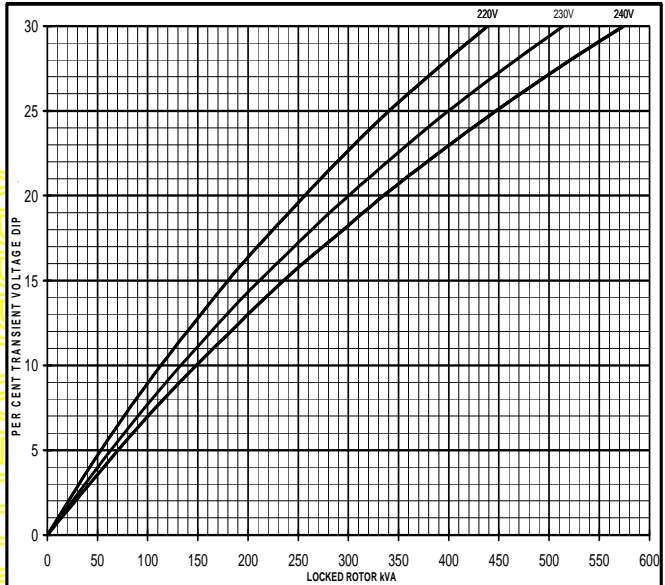
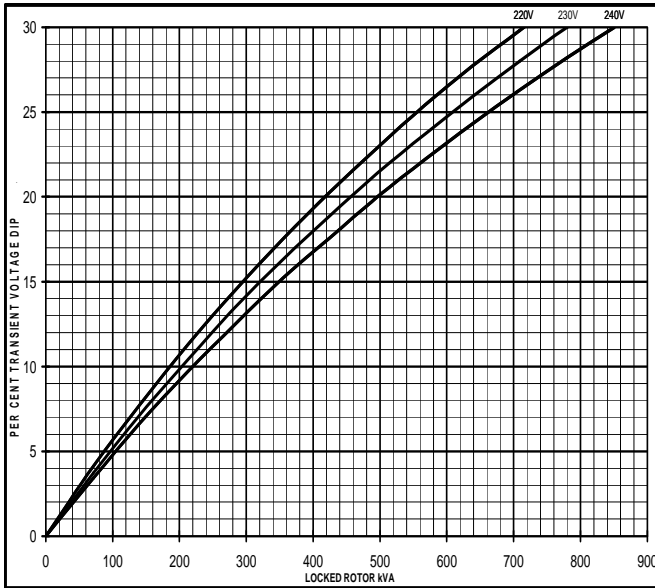

60
Hz

MX

SX

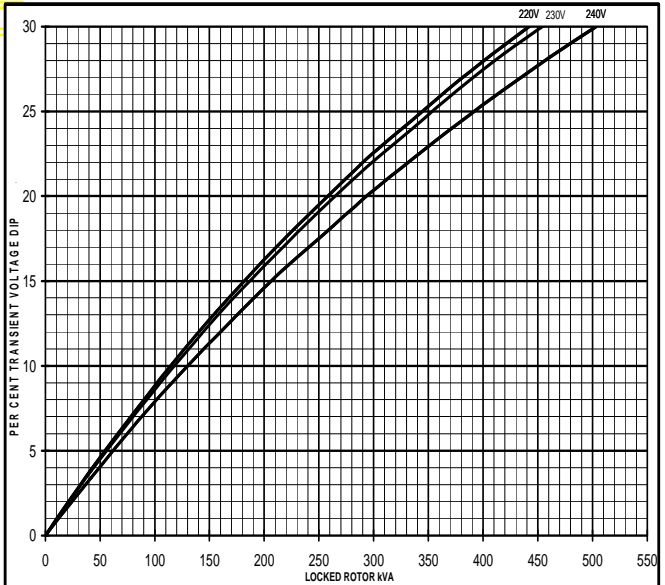
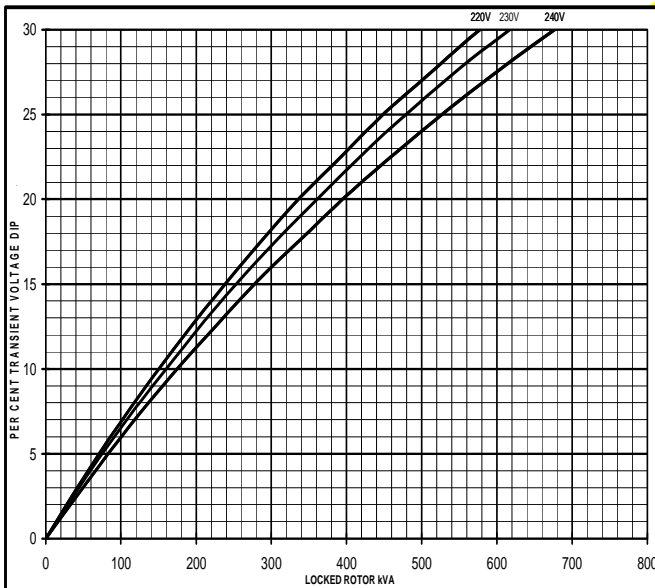

**Winding 311 Single Phase
Single Phase Short Circuit Decrement Curve. No-load Excitation at Rated Speed
Based on Double Delta connection.**

50
Hz

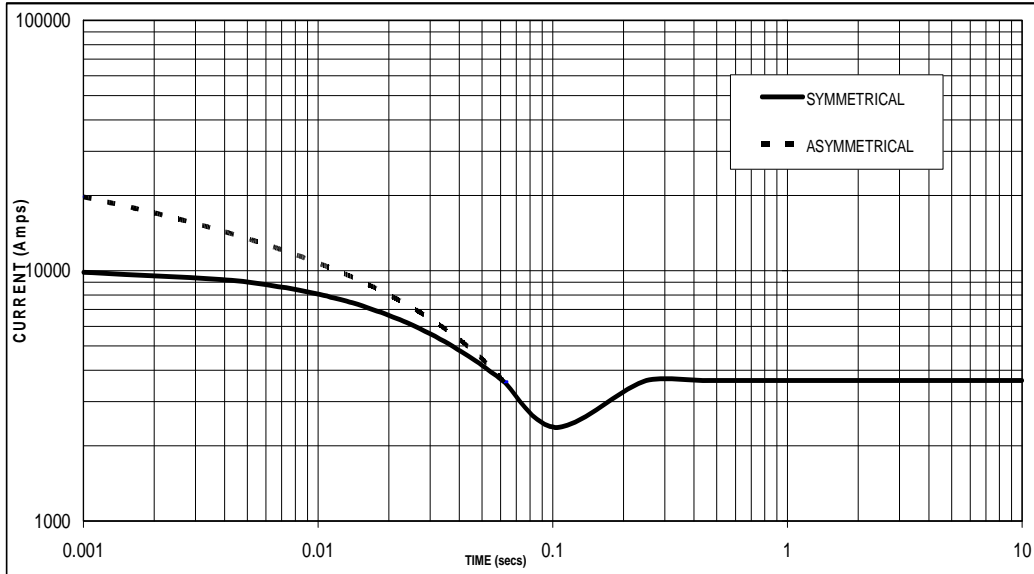

Sustained Short Circuit = 3636 Amps

60
Hz

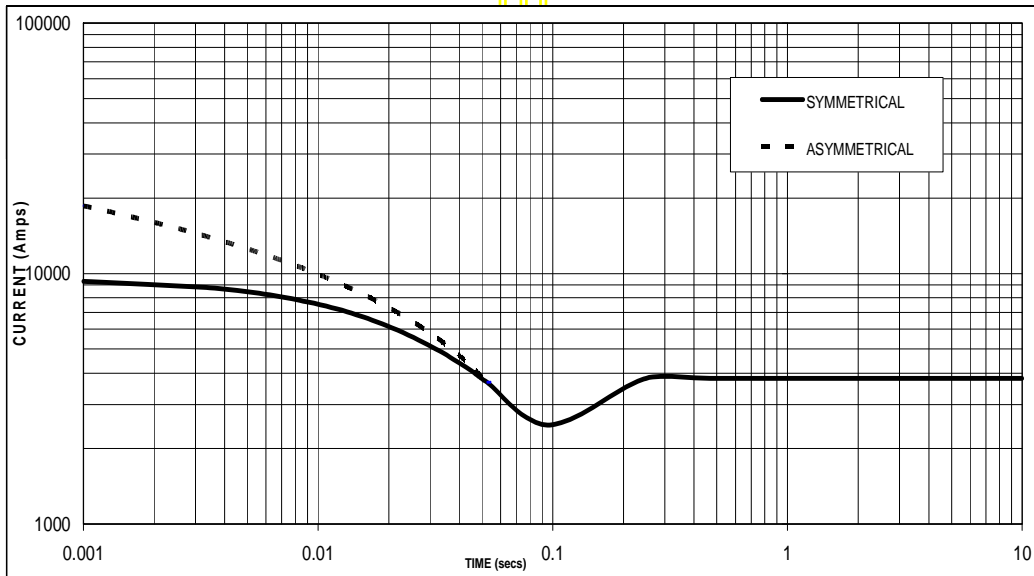

Sustained Short Circuit = 3818 Amps

Note

The following multiplication factors should be used to adjust the values from curve between time 0.001 seconds and the minimum current point in respect of nominal operating voltage :

Voltage	Factor
220V	X 1.00
230V	X 1.05
240V	X 1.09

The sustained current value is constant irrespective of voltage level

HCI434F/444F

Winding 311 Single Phase



RATINGS

Class - Temp Rise	Cont. F - 105/40°C			Cont. H - 125/40°C			Cont. F - 105/40°C			Cont. H - 125/40°C			
	0.8pf			0.8pf			1.0pf			1.0pf			
50	Double Delta (V)	220	230	240	220	230	240	220	230	240	220	230	240
	Parallel Delta (V)	110	115	120	110	115	120	110	115	120	110	115	120
	kVA	185	185	185	200	200	200	185	185	185	200	200	200
	kW	148	148	148	160	160	160	185	185	185	200	200	200
	Efficiency (%)	90.7	90.8	90.9	90.6	90.7	90.8	92.8	92.9	92.9	92.7	92.8	92.9
	kW Input	163	163	163	177	176	176	199	199	199	216	216	215

Class - Temp Rise	Cont. F - 105/40°C			Cont. H - 125/40°C			Cont. F - 105/40°C			Cont. H - 125/40°C			
	0.8pf			0.8pf			1.0pf			1.0pf			
60	Double Delta (V)	220	230	240	220	230	240	220	230	240	220	230	240
	Parallel Delta (V)	110	115	120	110	115	120	110	115	120	110	115	120
	kVA	195	200	210	210	220	230	195	200	210	210	220	230
	kW	156	160	168	168	176	184	195	200	210	210	220	230
	Efficiency (%)	90.6	90.8	90.9	90.5	90.6	90.7	92.6	92.7	92.8	92.5	92.6	92.7
	kW Input	172	176	185	186	194	203	211	216	226	227	238	248

DIMENSIONS

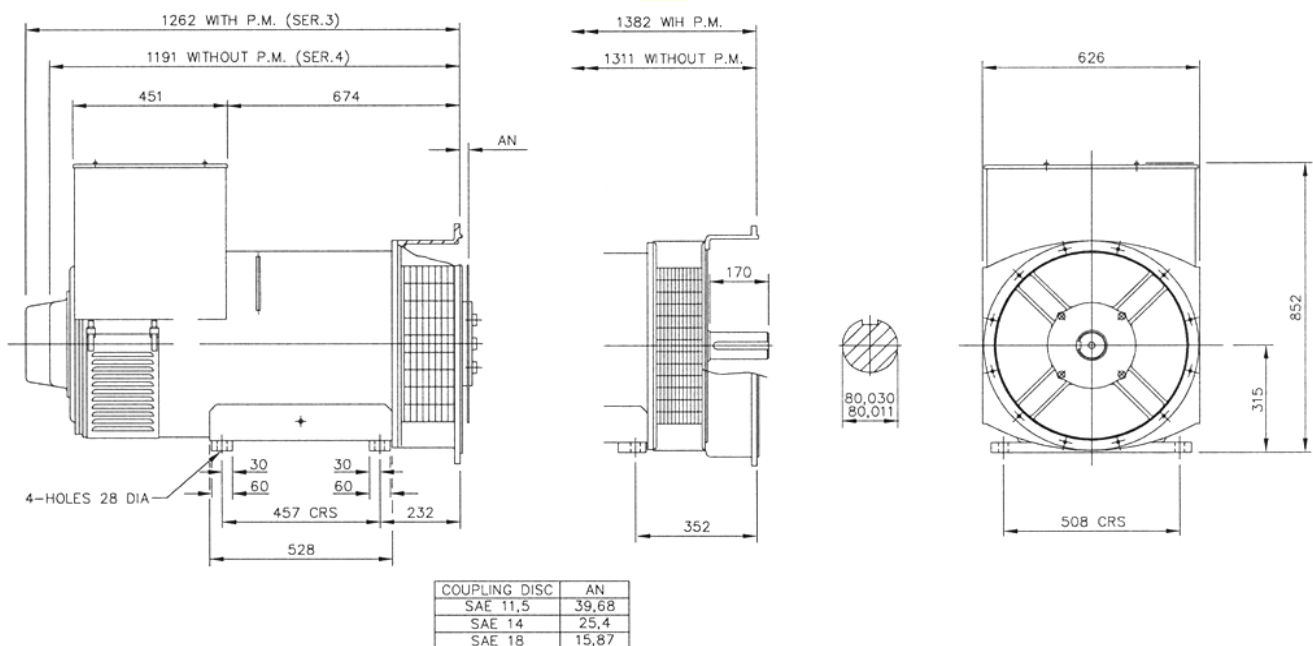

APPROVED DOCUMENT

STAMFORD

Head Office Address:
Barnack Road, Stamford
Lincolnshire, PE9 2NB
United Kingdom
Tel: +44 (0) 1780 484000
Fax: +44 (0) 1780 484100

www.cumminsgeneratortechnologies.com

Copyright 2010, Cummins Generator Technologies Ltd, All Rights Reserved
Stamford and AvK are registered trade marks of Cummins Generator Technologies Ltd
Cummins and the Cummins logo are registered trade marks of Cummins Inc.